



ACTIVE PA SYSTEM

T E S S E N



TNX-158I

TNX-150I

TNX-120I

TNX USER MANUAL



GENERAL INSTRUCTIONS

In order to take full advantage of your new product and enjoy long and trouble-free performance, please read this owner's manual carefully, and keep it in a safe place for future reference.

1) Unpacking: On unpacking your product please check carefully for any signs of damage that may have occurred whilst in transit from the HH factory to your dealer. In the unlikely event that there has been damage, please re-pack your unit in its original carton and consult your dealer. We strongly advise you to keep your original transit carton, since in the unlikely event that your unit should develop a fault, you will be able to return it to you dealer for rectification securely packed.

2) Amplifier Connection: In order to avoid damage, it is advisable to establish and follow a pattern for turning on and off your system. With all system parts connected, turn on source equipment, tape decks, cd players, mixers, effects processors etc, BEFORE turning on your amplifier. Many products have large transient surges at turn on and off which can cause damage to your speakers.

By turning on your bass amplifier LAST and making sure its level control is set to a minimum, any transients from other equipment should not reach your loud speakers. Wait till all system parts have stabilised, usually a couple of seconds. Similarly when turning off your system always turn down the level controls on your bass amplifier and then turn off its power before turning off other equipment

3) Cables: Never use shielded or microphone cable for any speaker connections as this will not be substantial enough to handle the amplifier load and could cause damage to your complete system.

4) Servicing: The user should not attempt to service these products. Refer all servicing to qualified service personnel.

FCC COMPLIANCY STATEMENT



This device complies with Part 15 of the FCC rules Operation is subject to the following two conditions:

- 1) This device may not cause harmful interference
- 2) This device must accept any interference received, that may cause undesired operation.

Warning: Changes or modification to the equipment not approved by HH Electronics Ltd. can void the user's authority to use the equipment.

Note: This equipment has been tested and found to comply with the limits for Class B digital device, pursuant to Part 15 of the FCC Rules. These limits are designed to provide reasonable protection against harmful interference in a residential installation. This equipment generates, uses and can radiate radio frequency energy and if not installed and used in accordance with the instructions, may cause harmful interference to radio communications. However, there is no guarantee that interference will not occur in a particular installation. If this equipment does cause harmful interference to radio or television reception, which can be determined by turning the equipment off and on, the user is encouraged to try and correct the interference by one or more of the following measures.

Reorient or relocate the receiving antenna.

Increase the separation between the equipment and receiver.

Connect the equipment into an outlet on a circuit different from that to which the receiver is connected.

Consult the dealer or an experienced radio/TV technician for help.



This product conforms to the requirements of the following European Regulations, Directives & Rules:

CE Mark (93/68/EEC), Low Voltage (2014/35/EU), EMC (2014/30/EU), RoHS (2011/65/EU), ErP (2009/125/EU).



In order to reduce environmental damage, at the end of its useful life, this product must not be disposed of along with normal household waste to landfill sites. It must be taken to an approved recycling centre according to the recommendations of the WEEE (Waste Electrical and Electronic Equipment) directive applicable in your country.

<http://support.hhelectronics.com/approvals>

1. Read these instructions.
2. Keep these instructions safe.
3. Heed all warnings.
4. Follow all instructions.
5. Do not use this apparatus near water.
6. Clean only with a dry cloth.
7. Do not block any of the ventilation openings. Install in accordance with manufacturer's instructions.
8. Do not install near any heat sources such as radiators, heat registers, stoves or other apparatus (including amplifiers) that produce heat.
9. An apparatus with Class I construction shall be connected to a mains socket outlet with a protective connection. Do not defeat the safety purpose of the polarized or grounding-type plug. A polarized plug has two blades with one wider than the other. A grounding type plug has two blades and a third grounding prong. The wide blade or third prong is provided for your safety. If the provided plug does not fit into your outlet, consult an electrician for replacement of the obsolete outlet.
10. Protect the power cord from being walked on or pinched, particularly at plugs, convenience receptacles, and the point they exit from the apparatus.
11. Only use attachments/accessories provided by the manufacturer.
12. Use only with a cart, stand, tripod, bracket, or table specified by the manufacturer, or sold with the apparatus. When a cart is used, use caution when moving the cart/apparatus combination to avoid injury from tip-over.
13. The mains plug or appliance coupler is used as the disconnect device and shall remain readily operable. The user should allow easy access to any mains plug, mains coupler and mains switch used in conjunction with this unit thus making it readily operable. Unplug this apparatus during lightning storms or when unused for long periods of time.
14. Refer all servicing to qualified service personnel. Servicing is required when the apparatus has been damaged in any way, such as when power-supply cord or plug is damaged, liquid has been spilled or objects have fallen into the apparatus, the apparatus has been exposed to rain or moisture, does not operate normally, or has been dropped.
15. Never break off the ground pin. Connect only to a power supply of the type marked on the unit adjacent to the power supply cord.
16. If this product is to be mounted in an equipment rack, rear support should be provided.
17. Note for UK only: If the colours of the wires in the mains lead of this unit do not correspond with the terminals in your plug, proceed as follows:
 - a) The wire that is coloured green and yellow must be connected to the terminal that is marked by the letter E, the earth symbol, coloured green or coloured green and yellow.
 - b) The wire that is coloured blue must be connected to the terminal that is marked with the letter N or the colour black.
 - c) The wire that is coloured brown must be connected to the terminal that is marked with the letter L or the colour red.
18. This electrical apparatus should not be exposed to dripping or splashing and care should be taken not to place objects containing liquids, such as vases, upon the apparatus.
19. Exposure to extremely high noise levels may cause a permanent hearing loss. Individuals vary considerably in susceptibility to noise-induced hearing loss, but nearly everyone will lose some hearing if exposed to sufficiently intense noise for a sufficient time.
The U.S. Government's Occupational Safety and Health Administration (OSHA) has specified the following permissible noise level exposures: According to OSHA, any exposure in excess of the above permissible limits could result in some hearing loss. Earplugs or protectors to the ear canals or over the ears must be worn when operating this amplification system in order to prevent a permanent hearing loss, if exposure is in excess of the limits as set forth above. To ensure against potentially dangerous exposure to high sound pressure levels, it is recommended that all persons exposed to equipment capable of producing high sound pressure levels such as this amplification system be protected by hearing protectors while this unit is in operation.
20. Symbols & nomenclature used on the product and in the product manuals, intended to alert the operator to areas where extra caution may be necessary, are as follows:
Intended to alert the user to the presence of high 'Dangerous Voltage' within the products enclosure that may be sufficient to constitute a risk of electrical shock to persons.
Intended to alert the user of the presence of important operating and maintenance (Servicing) instructions in the literature accompanying the product.

Duration Per Day in Hours	Sound Level dBA, slow response
8	90
6	92
4	95
3	97
2	100
1 1/2	102
1	105
1/2	110
1/4 ou inférieur	115

Risk of electrical shock - DO NOT OPEN. To reduce the risk of electrical shock, do not remove the cover. No user serviceable parts inside. Refer servicing to qualified personnel.



To prevent electrical shock or fire hazard, do not expose this appliance to rain or moisture. Before using this appliance please read the operating instructions.

If your appliance features a tilting mechanism or a kickback style cabinet, please use this design feature with caution. Due to the ease with which the amplifier can be moved between straight and tilted back positions, only use the amplifier on a level, stable surface. DO NOT operate the amplifier on a desk, table, shelf or otherwise unsuitable non-stable platform.

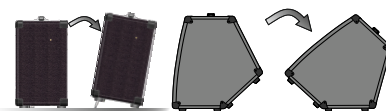

**FR****CONSIGNES DE SÉCURITÉ IMPORTANTES**

ATTENTION: L'utilisation de tout appareil électrique doit être soumise aux précautions d'usage incluant:

1. Lisez ces instructions
2. Gardez ce manuel pour de futures références.
3. Prêtez attention aux messages de précautions de ce manuel.
4. Suivez ces instructions.
5. N'utilisez pas cet appareil à proximité de plans d'eau.
6. N'utilisez qu'un tissu sec pour le nettoyage de votre appareil.
7. N'obstruez pas les systèmes de refroidissement de votre appareil et installez votre appareil en fonction des instructions de ce manuel.
8. Ne positionnez pas votre appareil à proximité de toute source de chaleur.
9. Un appareil avec la construction de la classe I sera relié à une prise munie d'une liaison à la terre. Branchez toujours votre appareil sur une alimentation munie de prise de terre utilisant le cordon d'alimentation fourni.
10. Protégez les connecteurs de votre appareil et positionnez les câblages pour éviter toutes déconnexions accidentelles.
11. N'utilisez que des fixations approuvées par le fabricant.
12. Lors de l'utilisation sur pied ou perche de support, assurez dans le cas de déplacement de l'ensemble enceinte/support de prévenir tout basculement intempestif de celui-ci.
13. La fiche secteur est utilisée pour couper l'alimentation de l'appareil et doit rester facilement accessible. Débranchez cet appareil pendant les orages ou s'il est inutilisé pendant de longues périodes.
14. Seul un technicien agréé par le fabricant est à même de réparer/contrôler votre appareil. Celui-ci doit être contrôlé s'il a subi des dommages de manipulation, d'utilisation ou de stockage (humidité, ...).
15. Ne déconnectez jamais la prise de terre de votre appareil.
16. Si votre appareil est destiné à être monté en rack, des supports arrière doivent être utilisés.
17. Note pour le Royaume-Uni : Si les couleurs des fils du câble d'alimentation ne correspondent pas aux fiches de la prise secteur, procédez comme suit:
 - a) Le fil vert et jaune doit être branché sur la borne repérée par la lettre E, ou le symbole de terre, ou par les couleurs vert ou verte et jaune.
 - b) Le fil bleu doit être branché sur la borne repérée par la lettre N, ou par la couleur noire.
 - c) Le fil marron doit être branché sur la borne repérée par la lettre L, ou par la couleur rouge.
18. Cet équipement électrique ne doit en aucun cas être en contact avec un quelconque liquide et aucun objet contenant un liquide, tels qu'un vase ou autre récipient.
19. Une exposition à de hauts niveaux sonores peut entraîner des dommages irréversibles de l'audition. La sensibilité au bruit varie considérablement d'un individu à l'autre, mais la majorité de la population ressentira une perte d'audition après une exposition à une forte puissance sonore pendant une durée prolongée. L'organisme de la santé américaine (OSHA) a produit le guide ci-dessous en rapport à l'exposition autorisée aux niveaux de bruit :
D'après les études menées par l'OSHA, toute exposition au delà des limites décrites ci-dessous entraînera des pertes de audition chez la plupart des sujets. Le port de système de protection (casque, oreillette de filtrage, etc...) doit être observé lors de l'utilisation de cet appareil sans quoi des dommages irréversibles peuvent être occasionnés. Le port de ces systèmes doit être observé par toutes personnes susceptibles d'être exposées à des conditions au delà des limites décrites ci-dessous.
20. Symboles utilisés sur les produits et dans les manuels des produits, destinés à alerter l'opérateur des zones ou des précautions supplémentaires pouvant être nécessaires :

Ce symbole est utilisé pour prévenir l'utilisateur de la présence d'une tension non isolée dangereuse à l'intérieur du boîtier de l'appareil, et pouvant être suffisante pour constituer un risque de choc électrique.

Ce symbole est utilisé pour prévenir l'utilisateur de la présence d'instructions d'utilisation et de maintenance dans le mode d'emploi accompagnant l'appareil.

Risque de choc électrique – NE PAS OUVRIR Afin de réduire les risques de choc électrique, ne pas ouvrir le capot. Il n'y a aucune pièce à l'intérieur pouvant être réparée par l'utilisateur. Veuillez confier la maintenance à un personnel qualifié.

Afin de prévenir tout risque de choc électrique et d'incendie, n'exposez pas cet appareil à la pluie ou à l'humidité. Avant d'utiliser cet appareil, lisez attentivement les instructions d'utilisation de ce mode d'emploi.

Si votre appareil est équipé d'un mécanisme de basculement ou si son boîtier est conçu comme retour, veuillez utiliser cette caractéristique avec prudence. En raison de la facilité avec laquelle l'amplificateur peut être basculé entre les positions droite et inclinée, utilisez uniquement l'amplificateur sur une surface plane et stable. NE PAS faire fonctionner l'amplificateur sur un bureau, une table, une étagère ou autre plate-forme inappropriée.

Durée par Jour (heures)	Niveau sonore moyen (dBA)
8	90
6	92
4	95
3	97
2	100
1 ½	102
1	105
½	110
¼ ou inférieur	115

**WICHTIGE SICHERHEITSHINWEISE**

ACHTUNG: Beim Einsatz von Elektrogeräten müssen u.a. grundlegende Vorsichtsmaßnahmen befolgt werden:

1. Lesen Sie sich diese Anweisungen durch.
2. Bewahren Sie diese Anweisungen auf.
3. Beachten Sie alle Warnungen.
4. Befolgen Sie alle Anweisungen.
5. Setzen Sie dieses Gerät nicht in der Nähe von Wasser ein.
6. Reinigen Sie es nur mit einem trockenen Tuch.
7. Blockieren Sie keine der Lüftungsöffnungen. Führen Sie die Installation gemäß den Anweisungen des Herstellers durch.
8. Betreiben Sie das Gerät nicht neben Wärmequellen wie Heizungen, Heizgeräten, Öfen oder anderen Geräten (auch Verstärkern), die Wärme erzeugen.
9. Verwenden Sie nur Kaltgeräte-Netzkabel aus dem Fachhandel.
10. Schützen Sie das Netzkabel, sodass niemand darauf tritt oder es geknickt wird, insbesondere an Steckern oder Buchsen am Gerät.
11. Verwenden Sie nur die vom Hersteller erhältlichen Zubehörgeräte oder Zubehörteile.
12. Verwenden Sie nur einen Wagen, Stativ, Dreifuß, Träger oder Tisch, der den Angaben des Herstellers entspricht oder zusammen mit dem Gerät verkauft wurde. Wird ein Wagen verwendet, bewegen Sie den Wagen mit dem darauf befindlichen Gerät besonders vorsichtig, damit es nicht umkippt und möglicherweise jemand verletzt wird.
13. Der Netzstecker bzw. Gerätestecker wird zum Trennen vom Stromnetz verwendet und muß immer leicht zugänglich sein. Der Benutzer sollte auf einfachen Zugang zu allen Netzsteckern, Gerätesteckern und Netz-Schaltern achten. Ziehen Sie den Netzstecker bei Gewitter heraus oder wenn das Gerät längere Zeit nicht benutzt wird.
14. Lassen Sie sämtliche Wartungsarbeiten von qualifizierten Kundendiensttechnikern durchführen. Eine Wartung ist erforderlich, wenn das Gerät in irgendeiner Art beschädigt wurde, etwa wenn das Netzkabel oder der Netzstecker beschädigt wurden, Flüssigkeit oder Gegenstände in das Gerät gelangt sind, das Gerät Regen oder Feuchtigkeit ausgesetzt wurde, nicht normal arbeitet oder heruntergefallen ist.
15. Schließen Sie das Gerät nur an eine Stromquelle an, die am Gerät neben dem Netzkabel angegeben ist.
16. Wenn dieses Produkt in ein Geräte-Rack eingebaut werden soll, muss eine Versorgung über die Rückseite eingerichtet werden.
18. Dieses Gerät darf nicht ungeschützt Wassertropfen und Wasserspritzern ausgesetzt werden und es muss darauf geachtet werden, dass keine mit Flüssigkeiten gefüllte Gegenstände, wie z. B. Blumenvasen, auf dem Gerät abgestellt werden.
19. Belastung durch extrem hohe Lärmpegel kann zu dauerhaftem Gehörverlust führen. Die Anfälligkeit für durch Lärm bedingten Gehörverlust ist von Mensch zu Mensch verschieden, das Gehör wird jedoch bei jedem in gewissem Maße geschädigt, der über einen bestimmten Zeitraum ausreichend starkem Lärm ausgesetzt ist. Die US-Arbeitsschutzbehörde (Occupational and Health Administration, OSHA) hat die folgenden zulässigen Pegel für Lärmbelastung festgelegt:
Laut OSHA kann jede Belastung über den obenstehenden zulässigen Grenzwerten zu einem gewissen Gehörverlust führen. Sollte die Belastung die obenstehenden Grenzwerte übersteigen, müssen beim Betrieb dieses Verstärkungssystems Ohrenstopfen oder Schutzvorrichtungen im Gehörgang oder über den Ohren getragen werden, um einen dauerhaften Gehörverlust zu verhindern. Um sich vor einer möglicherweise gefährlichen Belastung durch hohe Schalldruckpegel zu schützen, wird allen Personen empfohlen, die mit Geräten arbeiten, die wie dieses Verstärkungssystem hohe Schalldruckpegel erzeugen können, beim Betrieb dieses Geräts einen Gehörschutz zu tragen.
20. Symbole und Nomenklatur, die auf dem Produkt und in den Handbüchern stehen, sollen den Bediener auf die Bereiche, in denen besondere Vorsicht notwendig sein kann, alarmieren und sind wie folgt:

Sollen den Benutzer auf das Vorhandensein von "gefährlicher Hoch- Spannung" im Gerätegehäuse hinweisen, um die Gefahr eines elektrischen Schlags für Personen zu vermeiden..

Sollen den Benutzer auf das Vorhandensein wichtiger Betriebs- und Wartungsanweisungen in der beigelegten Dokumentation aufmerksam machen. Gefahr eines elektrischen Schlags - NICHT ÖFFNEN. Um die Gefahr eines elektrischen Schlags zu reduzieren, darf die Abdeckung entfernt werden. Keine zu wartenden Teile im Inneren. Überlassen Sie die Wartung qualifiziertem Fachpersonal.

Gefahr eines elektrischen Schlags - NICHT ÖFFNEN. Um die Gefahr eines elektrischen Schlags zu vermeiden, darf die Abdeckung nicht geöffnet werden.. Überlassen Sie die Wartung qualifiziertem Fachpersonal.

Wenn Ihr Gerät über einen Kippmechanismus oder eine "Tilt-back"- Funktion verfügt, benutzen Sie diese Funktion mit Vorsicht. Aufgrund der Leichtigkeit, mit der der Verstärker zwischen geraden und schrägen Rücken Positionen bewegt werden kann, verwenden Sie nur den Verstärker auf einer ebenen, stabilen Oberfläche. NICHT den Verstärker auf einem Schreibtisch, Tisch, Regal oder sonst eine ungeeignete nicht stabile Plattform stellen.

Dauer pro Tag in Stunden	Geräuschpegel dBA langsame Reaktion
8	90
6	92
4	95
3	97
2	100
1 ½	102
1	105
½	110
¼ oder weniger	115





ISTRUCCIONES IMPORTANTES DE SEGURIDAD

CUIDADO: Cuando use productos electrónicos, debe tomar precauciones básicas, incluyendo las siguientes:

1. Lea estas instrucciones.
2. Guarde estas instrucciones.
3. Haga caso de todos los consejos.
4. Siga todas las instrucciones.
5. No usar este aparato cerca del agua.
6. Limpiar solamente con un trapo seco.
7. No bloquear ninguna de las salidas de ventilación. Instalar de acuerdo a las instrucciones del fabricante.
8. No instalar cerca de ninguna fuente de calor como radiadores, estufas, hornos u otros aparatos (incluyendo amplificadores) que produzcan calor.
9. Un aparato con la construcción de clase I deberá conectarse a una toma de corriente que disponga una conexión con protección. No retire la patilla protectora del enchufe polarizado o con conexión a tierra. Un enchufe polarizado tiene dos clavijas, una más ancha que la otra. Un enchufe con toma de tierra tiene dos clavijas y un tercer diente de tierra. La clavija ancha (la tercera) se proporciona para su seguridad. Si el enchufe proporcionado no encaja en su toma de red, consulte a un electricista para que se reemplace por la obsoleta.
10. Proteja el cable de alimentación para que no sea pisado o pinchado, particularmente en los enchufes, habitáculos y el punto de salida del aparato.
11. Usar solamente componentes y accesorios proporcionados por el fabricante.
12. Usar solamente un carro, pie, tripode, o soporte especificado por el fabricante, o vendido junto al aparato. Cuando se use un carro, tenga cuidado al mover el conjunto carro/aparato para evitar que se dañe en un vuelco.
13. El cable de alimentación o conector del aparato se usa como dispositivo de desconexión y debe permanecer accesible. El usuario debe permitir un acceso fácil a cualquier entrada principal, interruptor haciéndolo así más operativo. Desenchufe este aparato durante tormentas eléctricas o cuando no se use en largos periodos de tiempo.
14. Para cualquier reparación, acuda a personal de servicio cualificado. Se requieren reparaciones cuando el aparato ha sido dañado de alguna manera, como cuando el cable de alimentación o el enchufe se han dañado, algún líquido ha sido derramado o algún objeto ha caído dentro del aparato, el aparato ha sido expuesto a la lluvia o la humedad, no funciona de manera normal, o ha sufrido una caída.
15. Nunca retire la patilla de Tierra. Conecte el aparato sólo a una fuente de alimentación del tipo marcado al lado del cable de alimentación.
16. Si este producto va a ser instalado en una unidad de rack, use algún tipo de apoyo trasero.
17. Nota para el Reino Unido solamente: Si los colores de los cables en el enchufe principal de esta unidad no corresponden con los terminales en su enchufe, proceda de la siguiente manera:
 - a) El cable de color verde y azul debe ser conectado al terminal que está marcado con la letra E, el símbolo de Tierra (earth), coloreado en verde o en verde y amarillo.
 - b) El cable coloreado en azul debe ser conectado al terminal que está marcado con la letra N o el color negro.
 - c) El cable coloreado en marrón debe ser conectado al terminal que está marcado con la letra L o el color rojo.
18. Este aparato eléctrico no debe ser sometido a ningún tipo de goteo o salpicadura y se debe tener cuidado para no poner objetos que contengan líquidos, como vasos, sobre el aparato.
19. La exposición a altos niveles de ruido puede causar una pérdida permanente en la audición. La susceptibilidad a la pérdida de audición provocada por el ruido varía según la persona, pero casi todo el mundo perderá algo de audición si se expone a un nivel de ruido suficientemente intenso durante un tiempo determinado. El Departamento para la Salud y para la Seguridad del Gobierno de los Estados Unidos (OSHA) ha especificado las siguientes exposiciones al ruido permisibles:

De acuerdo a OSHA, cualquier exposición que exceda los límites arriba indicados puede producir algún tipo de pérdida en la audición. Protectores para los canales auditivos o tapones para los oídos deben ser usados cuando se opere con este sistema de sonido para prevenir una pérdida permanente en la audición, si la exposición excede los límites indicados más arriba. Para protegerse de una exposición a altos niveles de sonido potencialmente peligrosa, se recomienda que todas las personas expuestas a equipamiento capaz de producir altos niveles de presión sonora, tales como este sistema de amplificación, se encuentren protegidas por protectores auditivos mientras esta unidad esté operando.

Duración por Día en Horas	Nivel de Sonido dBA, Respuesta Lenta
8	90
6	92
4	95
3	97
2	100
1 ½	102
1	105



La intención de alertar al usuario de la presencia de "tensión peligrosa" alto dentro del recinto los productos puede ser suficiente para constituir un riesgo de descarga eléctrica para las personas.

La intención de alertar al usuario de la presencia de importantes de operación y mantenimiento (servicio) en la literatura que acompaña al producto. Riesgo de choque eléctrico - NO ABRIR. Para reducir el riesgo de descarga eléctrica, no retire la cubierta. No hay piezas que el usuario pueda reparar. Solicite la revisión al personal cualificado.

Para evitar descargas eléctricas o incendios, no exponga este aparato a la lluvia ni a la humedad. Antes de usar este aparato, por favor lea las instrucciones de funcionamiento.

Si el aparato cuenta con un mecanismo de inclinación o un gabinete estilo de contragolpe, por favor use esta característica con precaución. Debido a la facilidad con que puede ser que el amplificador se mueva entre las posiciones recta e inclinada, utilice sólo el amplificador sobre una superficie nivelada y estable. NO haga funcionar el amplificador en un escritorio, mesa, estantería o plataforma no estable o no apta.

IMPORTANTI ISTRUZIONI DI SICUREZZA

AVVERTENZA: Quando si usano prodotti elettrici, alcune precauzioni dovrebbero essere sempre seguite, tra cui le seguenti:

1. Leggere queste istruzioni.
2. Conservare queste istruzioni di sicurezza.
3. Osservare tutte le avvertenze.
4. Seguire tutte le istruzioni.
5. Non utilizzare questo apparecchio vicino all'acqua.
6. Pulire solo con un panno asciutto.
7. Non ostruire le aperture di ventilazione. Installare in conformità con le istruzioni del produttore.
8. Non installare vicino a fonti di calore come radiatori, regolatori di calore, stufe o altri apparecchi (inclusi gli amplificatori) che producono calore.
9. Un apparecchio in Classe I deve essere collegato a una presa di corrente di rete con connessione di protezione. Non annullare l'obiettivo di sicurezza della spina polarizzata o con messa a terra. Una spina polarizzata ha due lame, una più larga dell'altra. Una spina con messa a terra ha due lame e un terzo polo di terra. La lama più larga o il terzo polo servono per la sicurezza. Se la spina fornita non è adatta alla propria presa, consultare un elettricista per la sostituzione della presa obsoleta.
10. Proteggere il cavo di alimentazione venga calpestato o schiacciato, soprattutto in corrispondenza delle spine, delle prese e al punto in cui esce dall'apparecchio.
11. Usare solo dispositivi opzionali / accessori forniti dal produttore.
12. Usare solo con un carrello, supporto, cavalletto, sostegno o tavola specificate dal produttore o venduti con l'apparecchio. Quando si usa un carrello, prestare attenzione, muovendo il carrello / la combinazione di apparecchi, a non ferirsi-over.
13. La spina dell'alimentazione o apparecchio viene utilizzato come dispositivo di scollegamento e deve restare sempre operativo. L'utente deve consentire un facile accesso a qualsiasi presa di rete, accoppiatore di rete e interruttore di rete utilizzato in combinazione con l'unità rendendo così facilmente accessibile. Scollegare l'apparecchio durante i temporali o se non viene utilizzato per lunghi periodi di tempo.
14. Per l'assistenza rivolgersi a personale qualificato. L'assistenza è necessaria quando l'apparecchio è stato danneggiato in qualsiasi modo, come ad esempio quando il cavo di alimentazione o la spina sono danneggiati, è stato versato del liquido o degli oggetti sono caduti all'interno, l'apparecchio è stato esposto a pioggia o umidità, non funziona normalmente, o è stato fatto cadere.
15. Non rompere il pin di terra. Collegare ad una presa di potenza del tipo indicato sull'apparecchio adiacente al cavo di alimentazione.
16. Se il prodotto deve essere montato in un rack, supporto posteriore dovrebbe essere fornito.
17. Nota per solo Regno Unito: Se i colori dei fili del cavo di alimentazione di questa unità non corrispondono con i terminali della spina, procedere come segue:
 - a) Il cavo colorato verde e giallo deve essere collegato al terminale contrassegnato con la lettera E, il simbolo di massa, di colore verde o di colore verde e giallo.
 - b) Il filo che è di colore blu deve essere collegato al terminale contrassegnato con la lettera N o il nero.
 - c) il cavo marrone deve essere collegato al terminale contrassegnato con la lettera L o di colore rosso.
18. This apparecchio elettrico non deve essere esposto a gocce o schizzi e si deve prestare attenzione a non posizionare oggetti contenenti liquidi, come vasi, sopra l'apparecchio.
19. L'esposizione a livelli sonori molto elevati può causare la perdita permanente dell'udito. Gli individui La sensibilità al rumore perdita dell'udito causata, ma quasi tutti si perde un po' di danni in caso di esposizione al rumore sufficientemente intenso per un tempo sufficiente.

Sicurezza sul lavoro del governo degli USA and Health Administration (OSHA) ha elaborato la seguente tabella di tolleranza ai rumori: Secondo l'OSHA, l'esposizione prolungata ai limiti riportati qui a fianco potrebbe causare perdita di udito. Tappi per le orecchie o protezioni per il condotto orecchie o sopra le orecchie devono essere indossati quando si adopera questo sistema di amplificazione, al fine di evitare la perdita permanente dell'udito, se si superano i limiti di cui sopra. Per assicurarsi contro un'esposizione potenzialmente pericolosa ad elevati livelli di pressione sonora, si raccomanda che tutte le persone esposte ad apparecchi in grado di produrre elevati livelli di pressione sonora, come questo sistema di amplificazione essere protetti da dispositivi di protezione dell'udito mentre l'unità è in funzione.

20. Simboli e nomenclatura utilizzati sul prodotto e nei manuali dei prodotti, finalizzate ad avvisare l'operatore di aree in cui cautela possono essere necessari, sono i seguenti:

Scopo di avvisare l'utente della presenza di 'tensioni pericolose' alta all'interno del prodotto che può essere sufficiente per costituire un rischio di scossa elettrica per le persone.

Destinato per avvisare l'utente della presenza di importanti operativi e di manutenzione (assistenza) nella documentazione che accompagna il prodotto.

Durée par Jour (heures)	Niveau sonore moyen (dBA)
8	90
6	92
4	95
3	97
2	100
1 ½	102
1	105
½	110
¼ ou inférieur	115



Rischio di scossa elettrica - NON APRIRE. Per ridurre il rischio di scosse elettriche, non rimuovere il coperchio. Non ci sono parti riparabili dall'utente. Per la manutenzione rivolgersi a personale qualificato.

Per evitare scosse elettriche o incendi, non esporre questo apparecchio alla pioggia o all'umidità. Prima di utilizzare questo apparecchio leggere le istruzioni per l'uso.

Se il vostro apparecchio è dotato di un meccanismo di inclinazione o di un mobile in stile contraccollo, si prega di utilizzare questa caratteristica di design con cautela. A causa della facilità con cui l'amplificatore può essere spostato tra le posizioni schiena dritta e inclinata, utilizzare solo l'amplificatore su una superficie piana e stabile. NON utilizzare l'amplificatore su una scrivania, tavolo, uno scaffale o comunque inadatti piattaforma nonstabile.



PT

INSTRUÇÕES DE SEGURANÇA

AVISO: Ao usar produtos elétricos, adverte básica devem ser sempre seguidas, incluindo as seguintes:

1. Leia estas instruções.
2. Guarde estas instruções de segurança.
3. Preste atenção a todos os avisos.
4. Siga todas as instruções.
5. Não use este aparelho perto da água.
6. Limpe apenas com um pano seco.
7. Não bloqueie qualquer uma das aberturas de ventilação. Instale de acordo com as instruções do fabricante.
8. Não instale perto de fontes de calor, como radiadores, aquecedores, fogões ou outros aparelhos (incluindo amplificadores) que produzem calor.
9. Um aparelho com a construção de classe I devem ser conectado a uma tomada elétrica com ligação de proteção. Não anule a finalidade de segurança da ficha polarizada ou do tipo terra. Uma ficha polarizada possui duas lâminas, uma mais larga que a outra. Uma ficha do tipo terra tem duas lâminas e um terceiro pino de aterramento. A lâmina larga ou o terceiro pino são fornecidos para sua segurança. Se a ficha fornecida não encaixar na sua tomada, consulte um electricista para a substituição da tomada obsoleta.
10. Proteja o cabo de alimentação de pisadelas ou apertos, especialmente nas fichas, receptáculos de conveniência e no ponto de saída do aparelho.
11. Utilize apenas ligações / acessórios fornecidos pelo fabricante.
12. Use somente com o carrinho, estrutura, tripé, suporte, ou mesa especificados pelo fabricante ou vendidos com o aparelho. Quando utilizar um carrinho, tenha cuidado ao mover o conjunto carrinho / dispositivo para evitar danos provocados pela queda. 13. A ficha da tomada ou aparelho forem utilizados como dispositivo de desconexão e deve estar sempre acessível. O usuário deve permitir o acesso fácil a qualquer ficha, acoplador de alimentação e interruptor de rede usada em conjunto com esta unidade, assim, tornando-o acessível. Desligue o aparelho durante tempestades com raios ou quando não for utilizado por longos períodos de tempo.
14. Solicite a assistência de pessoal qualificado. A manutenção é necessária quando o aparelho tiver sido danificado de qualquer maneira, como quando o cabo de alimentação ou a ficha estiverem danificados, líquido foi derramado ou objetos caídos dentro do aparelho, o aparelho tenha sido exposto à chuva ou umidade, não operar normalmente, ou se tiver caído.
15. Nunca quebre o pino terra. Ligue apenas a uma fonte de energia do tipo marcadas na unidade adjacente ao cabo de fornecimento de energia.
16. Se este produto for para ser montado em um bastidor de equipamentos, o suporte traseiro deve ser fornecido. 17. Nota para o Reino Unido: Se as cores dos fios do cabo de alimentação da unidade não correspondem com os terminais na ficha, faça o seguinte:
 - a) O fio que é colorido verde e amarelo tem de ser ligado ao terminal que está marcada com a letra E, o símbolo de terra, de cor verde ou colorido em verde e amarelo.
 - b) O fio é de cor azul, que tem de ser ligado ao terminal que está marcada com a letra N ou a cor preta.
 - c) O fio que é castanho deve ser ligado ao terminal que está marcada com a letra L ou a cor vermelha. Aparelhos elétricos.
18. This não deve ser exposto a respingos e os cuidados devem ser tomados para não colocar objetos que contenham líquidos, tais como vasos, sobre o aparelho.
19. A exposição a níveis de ruído extremamente alta pode causar uma perda permanente da audição. Os indivíduos variam consideravelmente a susceptibilidade ao ruído induzido perda de audição, mas quase todo mundo vai perder alguma audição se expostos a ruído suficientemente intensa durante um tempo suficiente.

Segurança do Trabalho do governo dos EUA e Administração de Saúde (OSHA) especificou os seguintes exposições de nível de ruído admissíveis: de acordo com OSHA, a exposição em excesso dos limites admissíveis acima poderia resultar em alguma perda de audição. Tampões ou protetores para o canal auditivo ou sobre as orelhas, deve ser usada quando se opera este sistema de amplificação de modo a evitar a perda permanente da audição, se a exposição for superior a dos limites tal como descrito acima. Para garantir contra a exposição potencialmente perigoso para elevados níveis de pressão de som, recomenda-se que todas as pessoas expostas a um equipamento capaz de produzir níveis elevados de pressão sonora, como este sistema de amplificação de ser protegidos por protetores auditivos enquanto esta unidade está em operação.
20. Símbolos e nomenclatura utilizados no produto e nos manuais de produtos, destinados para alertar o operador para as áreas onde o cuidado extra pode ser necessário, são os seguintes:

duração por Dia em Horas	DBA Nível de som, resposta lenta
8	90
6	92
4	95
3	97
2	100
1 1/2	102
1	105
1/2	110
1/4 or less	115



Com a intenção de alertar o utilizador para a presença de "tensão perigosa" alto dentro do recinto produtos que poderá ser suficiente para constituir um risco de choque elétrico para as pessoas.

Com a intenção de alertar o usuário da presença de importantes de operação e manutenção (assistência) na literatura que acompanha o produto.

Risco de choque elétrico - NÃO ABRA. Para reduzir o risco de choque elétrico, não remover a tampa. Não existem peças no interior. Consulte um técnico qualificado.

Para evitar choque elétrico ou risco de incêndio, não exponha este aparelho à chuva ou umidade. Antes de utilizar este aparelho, leia atentamente as instruções de operação.

Se o seu aparelho possui um mecanismo de inclinação ou um armário estilo propina, por favor, use esse recurso de design com cautela. Devido à facilidade com que o amplificador pode ser movida entre as posições de costas rectas e inclinada, usar apenas o amplificador numa superfície plana e estável. NÃO operar o amplificador em uma escrivaninha, mesa, prateleira ou de alguma forma inadequada plataforma nonstable.

重要安全说明

警告：使用电器产品时，应始终遵循基本的注意事项，包括以下各项：

1. 阅读这些说明。
2. 确保此类说明放置于安全处。
3. 注意所有警告。
4. 请遵守所有说明。
5. 请勿在近水处使用该电器。
6. 仅可用于布清洁该电器。
7. 请勿堵塞该电器上的任何通风口。根据制造商的说明进行安装。
8. 请勿将该电器安装在靠近热源，如散热器、热风机、炉子或其他发热设备（包括功率放大器）。
9. 与 I 类建筑设备连接时，应连接到带保护的电源插座上。不要忽视视性或接地类型插头的安全作用。极性插头具有两个片状电极，其中一个较宽。接地类型插头具有两个片状电极和第三只接地脚。宽片状电极或第三只接地极用于保证使用者及电器的安全。如所提供的插头不适用于插座，须请专业人员更换，切勿自行更换电源插座。
10. 保护电源线，不被踩踏或挤压，尤其在插头、插座及与电源线的连接处。
11. 仅可采用制造商提供的附件或配件。
12. 仅可使用制造商指定的、或与该电器一同出售的货车、台架、三脚架、支架或台桌。使用货车，及移动货车/搬运该电器时，须注意，避免倾翻产生损坏。
13. 电源插头或该电器的转接插头，应保持其易操作性。用户应使用与该电器匹配的电源插头、连接器和电源开关，易于操作。在雷雨或长时间不使用时，拔下该电源插头。
14. 当该电器受到任何方式的损坏时，如：电源线或插头被损坏、液体泼溅或物体落入电器内、该电器放置于有雨水或潮湿处、及该电器坠落后，无法正常运行时，需进行检修时，必须有资格认证的维修人员进行维修。
15. 请勿折断电源插头上的接地极。仅可连接到在插头的片状电极旁边已标有符号的极性上。
16. 如此电器须安装在设备架上，应提供后部支架。
17. 仅适用于英国的注意事项。如该电器的电源线上电缆颜色与插头片状电极不相符，请按照以下步骤进行操作：
 - a) 黄绿色电缆须连接至标有字母“E”的电极，为接地符号。颜色为黄绿色或绿色。
 - b) 蓝色电缆须连接至标有字母“N”的电极，颜色为蓝色或黑色。
 - c) 棕色电缆须连接至标有字母“L”的电极，颜色为棕色或红色。
18. 该电器不能放置于有水滴或有水溅出的地方，须注意，不要将盛有液体的容器，如花瓶放在该电器上。
19. 如果人处于极高噪音级中可能会造成永久失聪。每个人受噪音导致听力损害的差异很大。然而若长时间处于极强噪音中，任何人几乎都会造成不同程度的听力损害。美国政府职业安全健康管理局（OSHA）指定了以下允许范围内的噪音级别，见右表：根据 OSHA，任何超出上述允许的极限范围可致不同程度的听力损害。在运行该电器时，人体处于超出了以上设定的限制，须佩戴耳塞或配备耳朵的保护装置，以预防永久性听力损害。为避免可能处于强声压程度的危险，该电器运行时，建议处于强声压程度下的所有人都配备听力保护装置。
20. 用于产品和说明书上的符号和术语是为了提醒操作人员注意需要额外注意的地方，具体如下：

每天持续时间 (小时)	噪声程度 (dBA) 缓慢反应
8	90
6	92
4	95
3	97
2	100
1 1/2	102
1	105
1/2	110
1/4 或更少	115

旨在提醒使用者小心产品空箱内的未绝缘“危险电压”，这可能足以对人构成触电危险。



旨在提醒使用者与产品一起提供的说明书中的重要操作和维护（保修）说明。小心触电-不能打开

为了降低触电风险，请不要打开盖子。里面不含任何用户可用的配件。请将维修交于被许可的人员。

为避免触电或火灾，请不要将本产品置于雨中或潮湿环境中。在使用本产品前，请仔细阅读操作说明。

21. 该产品仅适用于海拔2000m以下地区安全使用 该产品仅适用于非热带气候条件下安全使用

如果你的产品是倾斜的结构或是后倾款式的箱体，请小心使用该设计特征。由于功放可以在直立和后倾方式之间转换，请在平坦、牢固的表面使用该产品。请不要在桌子、架子或其它不适合、不牢固的平台上使用该功放。

安全上の重要な注意事項

電子機器を使用する際は、下記の注意事項に従ってご使用ください。

ご使用前には必ずこの説明書をお読みください。

説明書は大切に保管してください。

すべての注意事項を確認してください。

水などの液体を本体にこぼしたり、内部にかからないように注意してください。

掃除するときは、乾いた布のみを使用してください。

通気孔は絶対に塞がないでください。

ラジエーター、ヒートレジスター、ストーブ等、熱を発する装置（アンプを含む）

の近くには決して置かないでください。

電源コードは、踏まれたりはさまれたりしないように注意してください。

メーカーによって供給されたパーツ以外は使用しないでください。

キャスター等は、付属品を使用してください。転倒等の事故がないように十分注意してください。

長時間使用しない時、また雷雨の時などはコンセントを抜いてください。

電源コードやプラグの破損、強い衝撃や、液濡れ等の理由で正常に装置が動作しない場合は、ご購入店にご相談ください。

激しい騒音環境下では、永続的な難聴を引き起こす可能性があります。

騒音性 難聴への影響度には個人差がありますが、

激しい騒音の中にある一定の期間さらされた場合、

ほとんどの人の聴覚に悪影響を及ぼす可能性があります。米政府の

労働安全衛生局（OSHA）は、ノイズレベルの許容量（条件）

を定めています： OSHAによると、許容量を超える騒音は、

少なからず難聴に繋がる可能性があります。このアンプシステムを操作する際、

万が一制限値を超えている場合は、永続的な 難聴を防ぐためにも耳栓などを使用してください。

機材またはマニュアルに記載された記号、及び名称は、ご使用時に注意が必要なものとなります。

下記をご参照ください。



機材内部には、人に感電する危険性のある“高電圧”が流れている場合があります。

1日の時間数	騒音レベル(dBA) 応答が遅い
8	90
6	92
4	95
3	97
2	100
1 ½	102
1	105
½	110
1/4	それ以下

付属の冊子に書かれている操作上、または管理上（サービス上）重要な事項を確認してください。

製品カバーを開けないでください。感電の危険性を減らすためにも、蓋は取り外さないでください。

内部にはユーザーが修理できる部品はありません。資格ある技術者の指示を仰いでください。

感電や火災の危険を防止するため、この装置を雨や湿気にさらさないでください。使用する前には、必ず取扱説明書をお読みください。

（アンプを使用しないときは、スイッチをオフにし、電源コードは抜いてください）

場合は、アプライアンスの機能傾斜機構やキックバック スタイルのキャビネットは、

注意してこのデザイン機能を使用してください。

アンプ ストレートと戻って傾斜の位置間で移動できますがしやすさのため、

水平で安定した表面に、アンプのみ使用します。

デスク、テーブル、

棚またはそれ以外の場合に不適切な

nonstable プラットフォーム上増幅器を

操作しないでください。



Intended to alert the user to the presence of uninsulated 'Dangerous Voltage' within the products enclosure that may be sufficient to constitute a risk of electrical shock to persons.

Ce symbole est utilise pur indiquer a l'utilisateur de ce produit de tension non-isolee dangereuse pouvant etre d'intensite suffisante pour constituer un risque de choc electrique.

Este simbolo tiene el proposito de alertar al usuario de la presencia de '(voltaje) peligroso' que no tiene aislamiento dentro de la caja del producto que puede tener una magnitud suficiente como para constituir riesgo de corrientazo.

Dieses Symbol soll den Anwender vor unisolierten gefahrlichen Spannungen innerhalb des Gehauses warnen, die von Ausreichender Starke sind, um einen elektrischen Schlag verursachen zu konnen.



Intended to alert the user of the presence of important operating and maintenance (Servicing) instructions in the literature accompanying the product.

Dieses Symbol soll den Anwender vor unisolierten gefahrlichen Spannungen innerhalb des Gehauses warnen, die von Ausreichender Starke sind, um einen elektrischen Schlag verursachen zu konnen.

Este simbolo tiene el proposito de la alertar al usuario de la presencis de instrucccones importantes sobre la operacion y mantenimiento en la literatura que viene conel producto.

Dieses Symbol soll den Benutzer auf wichtige Instruktionen in der Bedienungsanleitung aufmerksam machen, die Handhabung und Wartung des Produkts betreffen.

CAUTION:

Risk of electrical shock - DO NOT OPEN.
To reduce the risk of electrical shock, do not remove the cover. No user serviceable parts inside. Refer servicing to qualified personnel.

ATTENTION:

Risques de choc electrique - NE PAS OUVIRIR
Afin de reduire le risque de choc electrique, ne pas enlever le couvercle. Il ne se trouve a l'interieur aucune piece pouvant etre reparee par l'utilisateur. Confier l'entretien a un personnel qualifie.

PRECAUCION:

Riesgo de corrientazo - no abra
Para disminuir el risego de carrientazo, no abra la cubierta. No hay piezas adentro que el pueda reparar. Deje todo mantenimiento a los tecnicos calificados.

VORSICHT:

Risiko - Elektrischer Schlag! Nicht offen!
Um das Risiko eines elektrischen Schlages zu vermeiden, nicht die Abdeckung entfernen. Es befinden sich keine Teile darin, die vom Anwender repariert werden Konnten. Reparaturen nur von qualifiziertem Fachpersonal durchfuhren lassen.

WARNING:

To prevent electrical shock or fire hazard, do not expose this appliance to rain or moisture. Before using this appliance please read the operating instructions for further warnings.

ADVERTISSEMENT:

Afin de prevenir les risques de decharge electrique ou de feu, n'exposez pas cet appareil a la pluie ou a l'humidite. Avant d'utiliser cet appareil, lisez les advertissements supplementaires situes dans le guide.

ADVERTENCIA:

Para evitar corrientazos o peligro de incendio, no deja expuesto a la lluvia o humedad este aparato Antes de usar este aparato, lea mas advertcias en la guia de operacion.

ACHTUNG:

Um einen elektrischen Schalg oder Feuergefahr zu vermeiden, sollte dieses Gerat nicht dem Regen oder Feuchtigkeit ausgesetzt werden. Vor Inbetriebnahme unbedingt die Bedienungsanleitung lesen.

EARTH or GROUND GREEN/YELLOW
NEUTRAL - BLUE
LIVE - BROWN



After unpacking your amplifier check that it is factory fitted with a three pin 'grounded' (or earthed) plug. Before plugging into the power supply ensure you are connecting to a grounded earth outlet.
If you should wish to change the factory fitted plug yourself, ensure that the wiring convention applicable to the country where the amplifier is to be used is strictly conformed to. As an example in the United Kingdom the cable colour code for connections are shown opposite.



CONFIGURATIONS

TNX models may be used in a number of ways:

- A: Tripod
- B: Freestanding
- C: Monitor
- D: Pole on SUB (Shown with HH TNS-I800 active sub)
- E: Stacked (Shown with HH TNS-I800 active sub)
- F: Flown Vertically
- G: Flown Horizontally

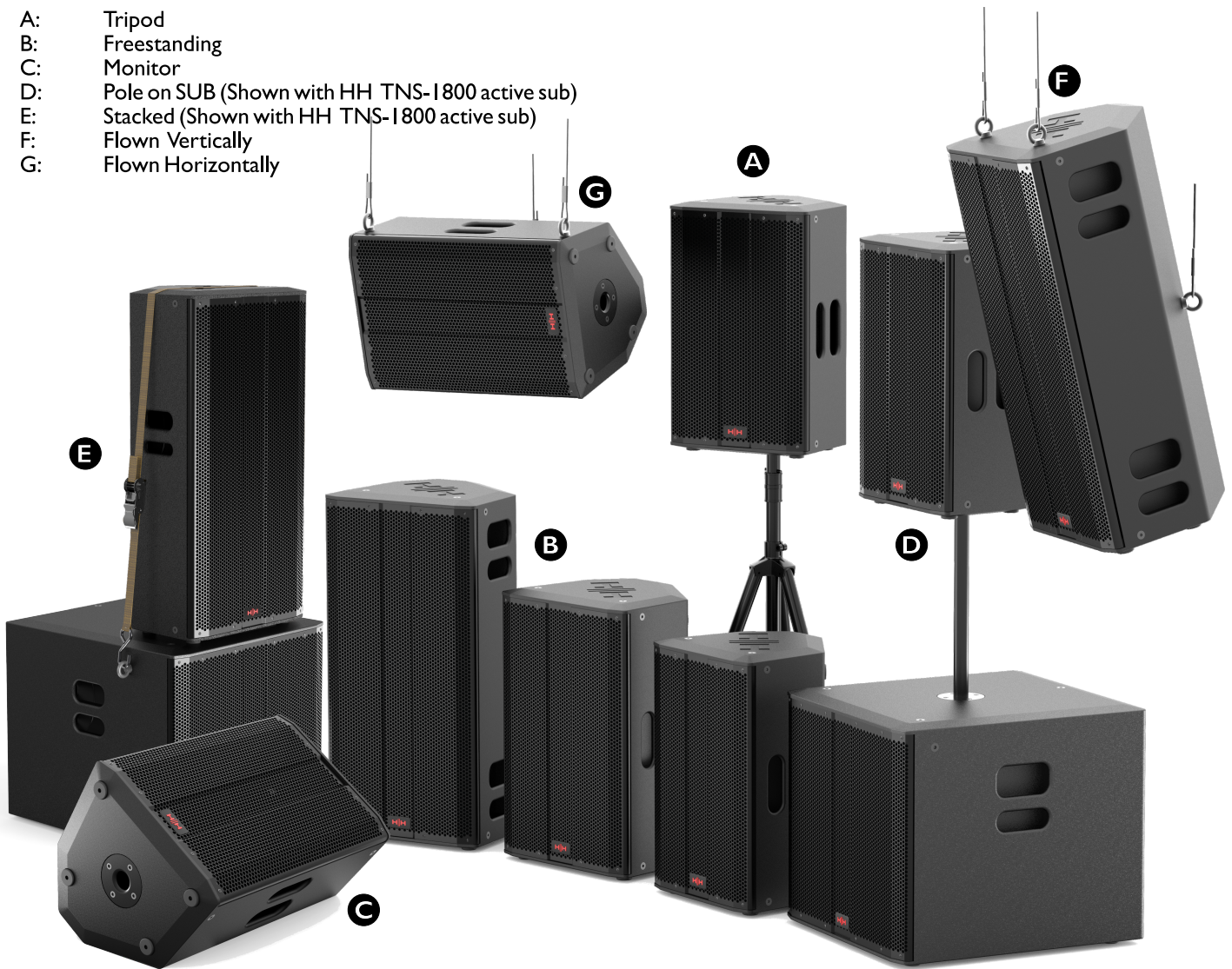

IMPORTANT

Ensure all speakers are balanced and steady. If in doubt, the M10 fly points can be replaced with Eye bolts which can be secured locally. If products are stacked, strap them together to improve stability. The fitted flying points can be used to improve safety in this instance.

The TNX-I201 and TNX-I501 are fitted with standard 35mm pole mounts on the underside. The user must ensure the products are installed and operated safely.

SUSPENDED

Tessen cabinets are fitted with M10 flying points for installation and suspended use.

Note that suspension or 'flying' of cabinets should be performed only by properly qualified persons, in compliance with all local laws and using approved hardware.

If you are not qualified, leave it to somebody who is. Failure to do so could result in serious injury or death! The rigging or suspended mounting of these speakers can expose members of the public to serious health risks or even death. Under no circumstances attempt to rig, suspend or otherwise mount this system unless you are fully qualified and certified to do so by relevant local, state and national authorities. All relevant safety regulations must be followed. If you are not properly qualified or do not know of pertinent regulations, consult qualified personnel for advice and assistance.



GETTING STARTED

This manual contains important information regarding correct and safe operation of your Tessen system. Please read it thoroughly in order to get the best performance and reliability from your HH product.

Inspect the product during unpacking. If any damage is found notify the dealer you purchased it from immediately. Should you ever need to return the unit back to the dealer or HH Electronics, ensure it is well packed and if possible use the original packaging.

POWER CYCLE

Many products have large transient surges at turn on and off which can cause damage to your speakers. Following the sequence below for power-up and the reverse for power down will prevent this from occurring.

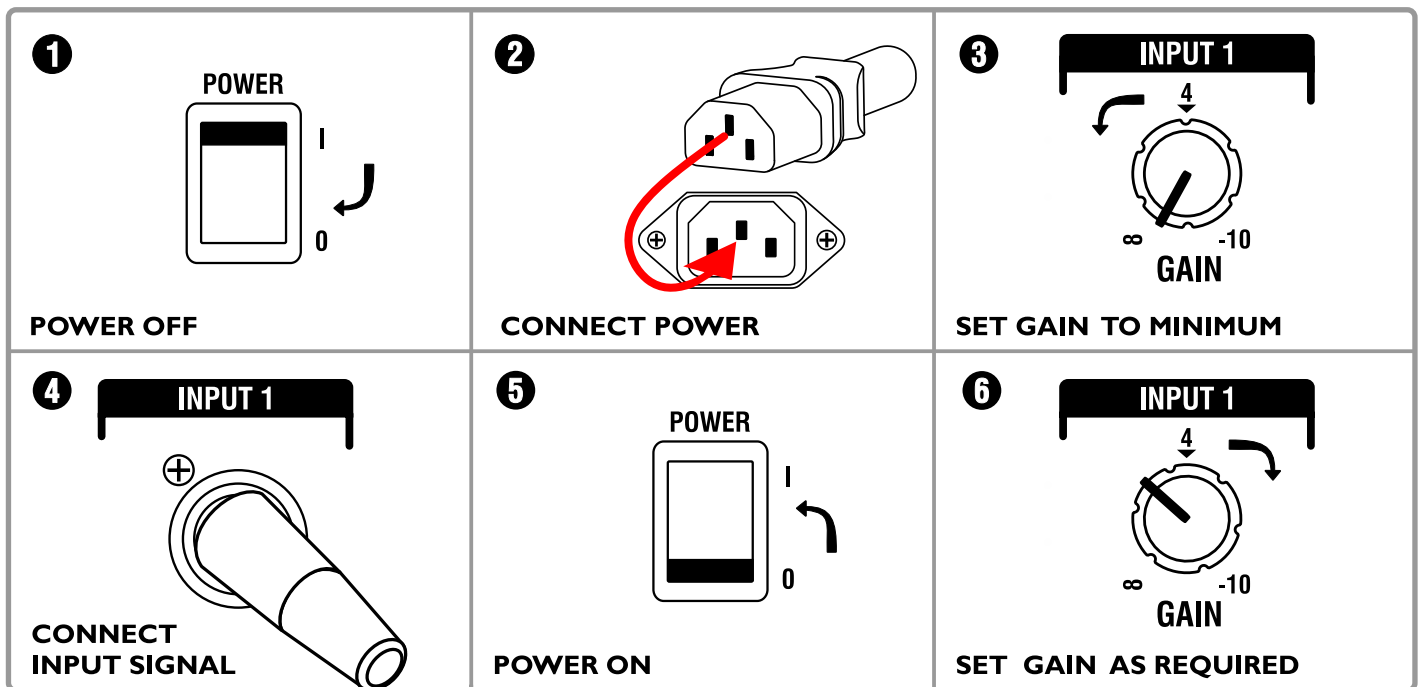



CONTROL PANEL

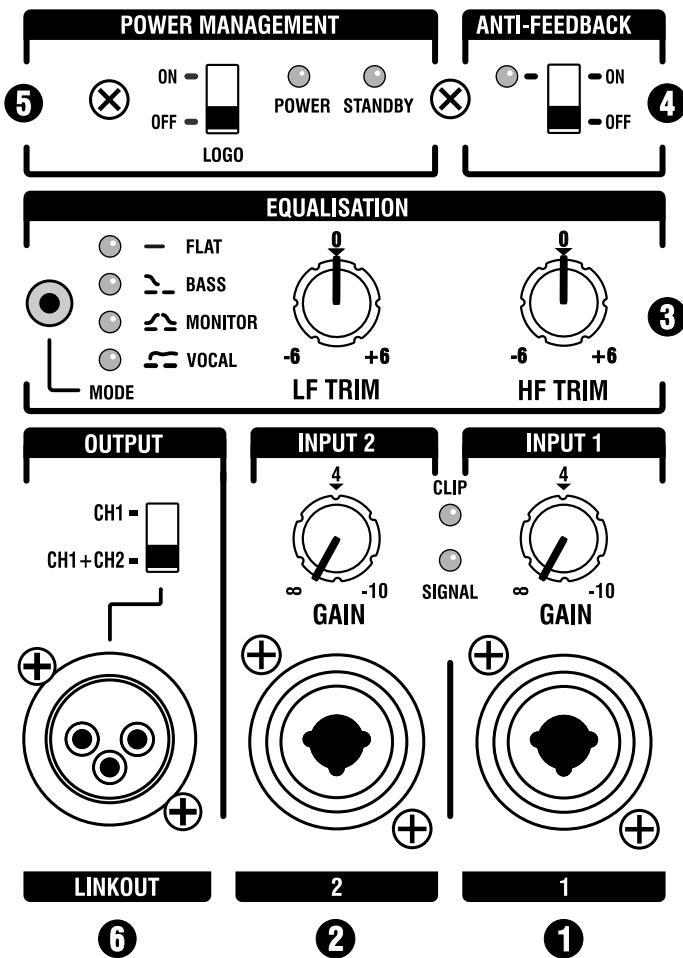

1 & 2. INPUTS: Line level balanced input compatible with balanced and unbalanced XLR and jack signal leads. *Note; as these are balanced input, a stereo signal on TRS lead cannot be connected directly, and must be split to two mono connectors*

GAIN: Use to set the overall output level of the unit.

CLIP: The clip led illuminates to indicated the output stage of the amplifier is or is on the edge of overloading. However, distortion will not occur due to the presence of the onboard limiter.

SIGNAL: This led will illuminate when a signal is detected at input 1 or 2.

3. EQUALISATION: The onboard DSP can be tailored to suit many different applications. Four presets are included to optimise the response of the cabinet to suit your needs; these can be further fine tuned with the LF and HF trim controls. Trim controls can be used to fine tune the bass or treble content to your venue/application.

FLAT: General purpose EQ setting.

BASS: Not just a typical smiley face, it adjusts many of the amplifier parameters to ensure huge tight bass.

MONITOR: This setting provides a bass cut and mid frequency boost ideal for cutting through on stage.

VOCAL: Decreases the amount of bass and emphasises the vocal content.

The EQ setting is stored and recalled, so it will be as you left it following a power cycle. Please note the unit is shipped with the EQ mode set to FLAT.

4. ANTI-FEEDBACK: When the Anti-Feedback control is enabled the Tessen actively and automatically searches for signs of feedback (over the entire audio frequency) and takes it out. This state of the art system uses ultra fine auto notch filters to control feedback without affecting your sound. As soon as the Tessen detects that the feedback has gone it will release the notch filter and continue searching. The Tessen system can find and eliminate up to 12 feedback sources at once which greatly reduces the possibility of feedback becoming a serious problem. It is advisable to leave this feature enabled if you are using mics.

5. POWER MANAGEMENT: The POWER led illuminates when the unit is connected to a suitable mains source and the Power Switch is set to on.

STANDBY mode is disabled by default, but other modes are also available.

Please see page 11 to adjust the standby mode.

LOGO: The illumination On/Off control for the HH logo located on the front grille.

6. LINK OUTPUT: A balanced XLR output allowing for this unit to be connected to additional active units (see page 11-12). Its signal is sourced post input stage (pre Gain control) and can be CH1 only or a combination of CH1 and CH2.

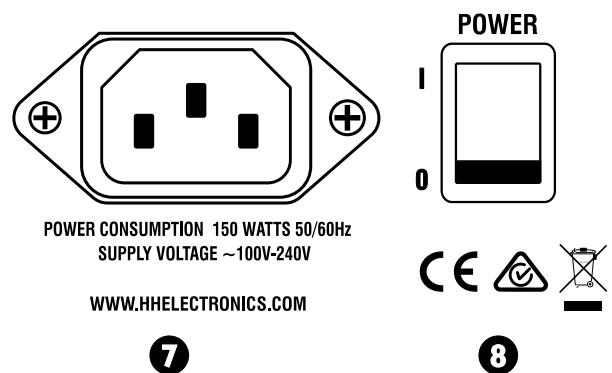

7. MAINS INLET IEC: A Universal mains input for worldwide usage without the need to change anything except your power cord.

8. MAINS SWITCH: Turns the system on and off. Ensure the Gain controls are set to minimum before switching on or off.

PLEASE OBSERVE THE PANEL SAFETY WARNINGS!



Used in conjunction with other members of the Tessen family, the TNX Active PA system provides the final component in a professional and complete audio solution.

The next two pages provide some possible setups, which are by no means exhaustive.

SETUP EXAMPLE 1

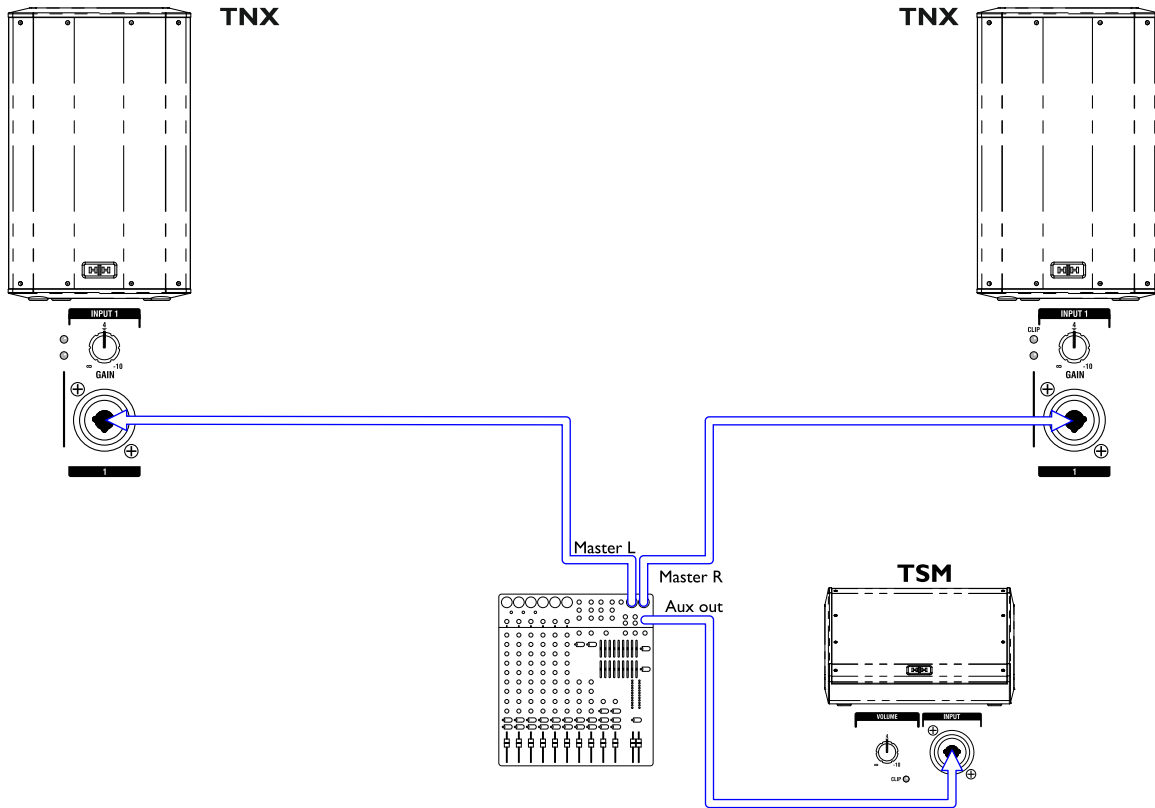

SETUP EXAMPLE 2

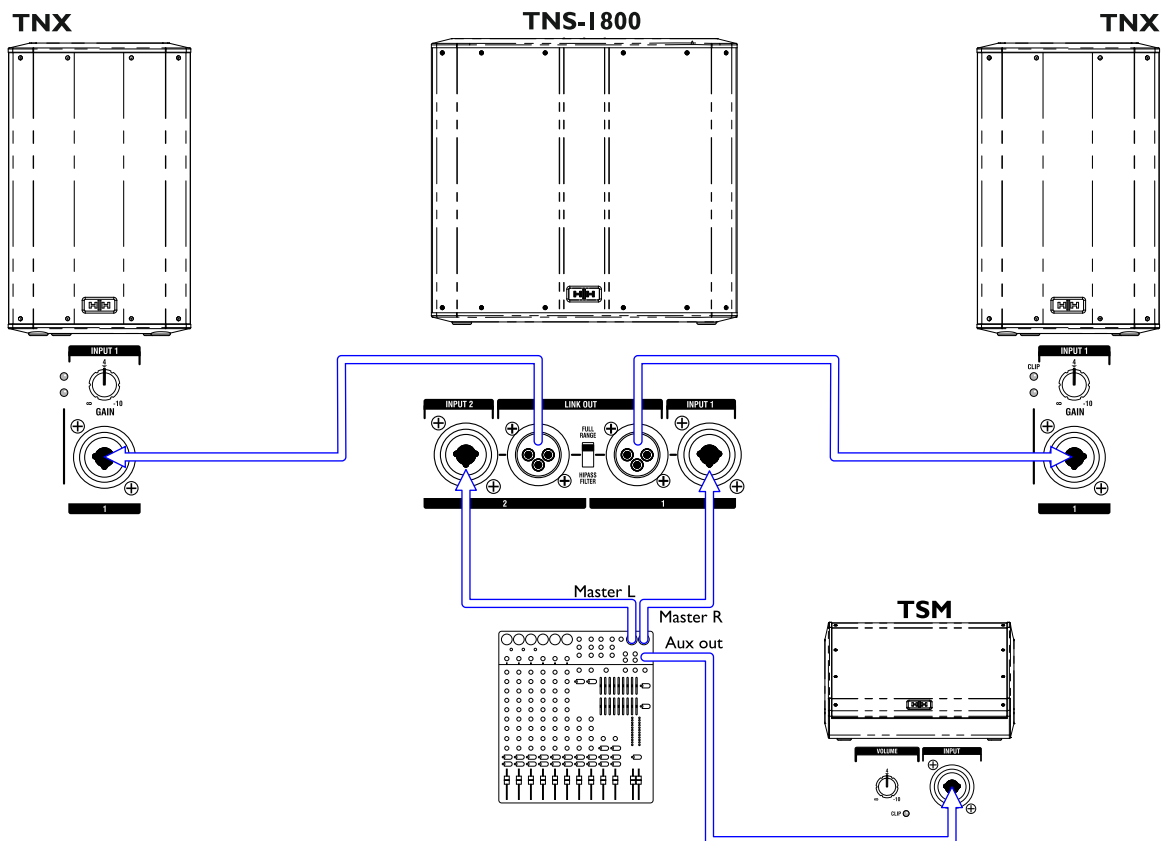



SETUP EXAMPLE 3

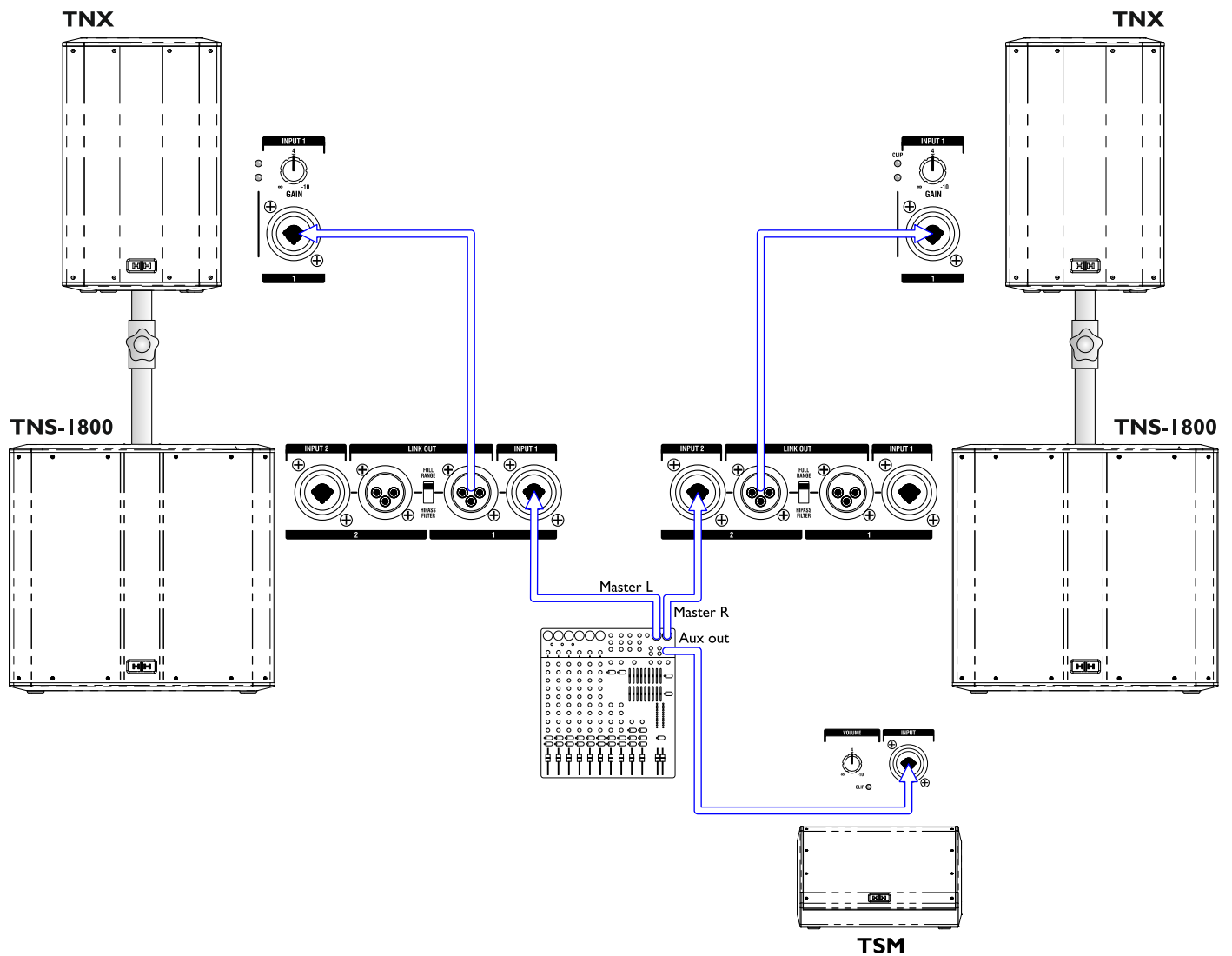



SUSPENSION

Tessen cabinets are fitted with M10 flying points for installation and suspended use.

Note that suspension or 'flying' of cabinets should be performed only by properly qualified persons, in compliance with all local laws and using approved hardware.

If you are not qualified, leave it to somebody who is. Failure to do so could result in serious injury or death!
The rigging or suspended mounting of these speakers can expose members of the public to serious health risks or even death. Under no circumstances attempt to rig, suspend or otherwise mount this system unless you are fully qualified and certified to do so by relevant local, state and national authorities. All relevant safety regulations must be followed. If you are not properly qualified or do not know of pertinent regulations, consult qualified personnel for advice and assistance.

SUSPENSION

1

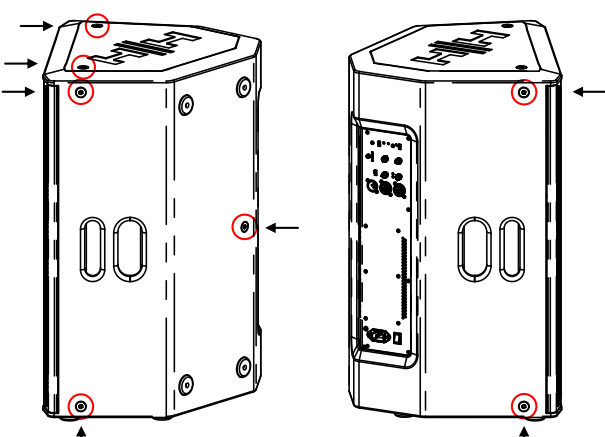

Remove the M10 x 35mm travel bolts and store for future use.

2

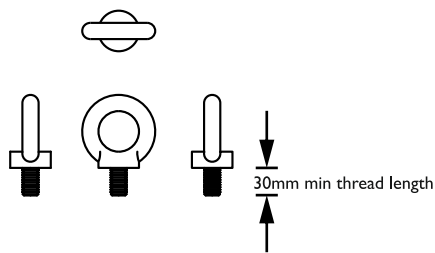

Replace with a suitable eye bolt. Ensure thread is fully engaged into insert
Note that eye bolts for flying systems must be cast, shouldered fittings rated for the purpose. Forged steel eye bolts of the type typically available from DIY suppliers are NOT suitable and should not be used under any circumstances.



STANDBY MODE

In addition to the factory setting (Standby Disabled), two other standby modes are available:

- 1: Standby mode is initiated following 25 minutes of inactivity - Standby led illuminates.
- 2: Standby mode is initiated following 10 minutes of inactivity - Standby led illuminates.

To adjust the standby mode, please follow the procedure outlined below.



The following procedure is to be performed by a confident/qualified person only! If you are not sure, please seek advice from your local repair centre.

1

Set power switch to off and disconnect IEC from mains inlet socket.

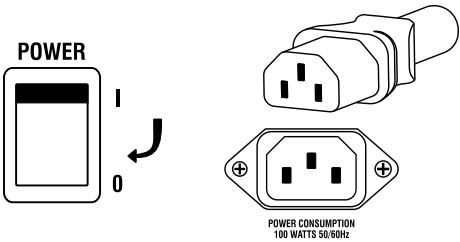

2

Remove the ten M3x8 screws.

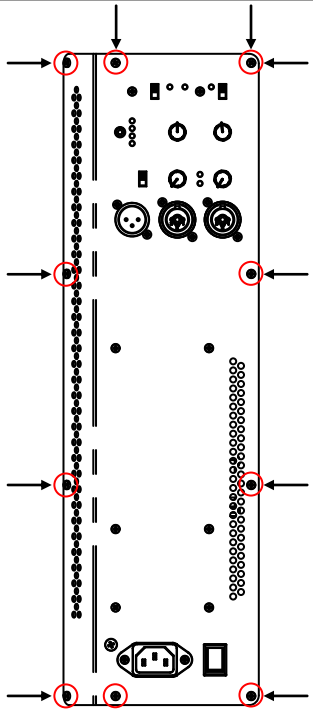

3

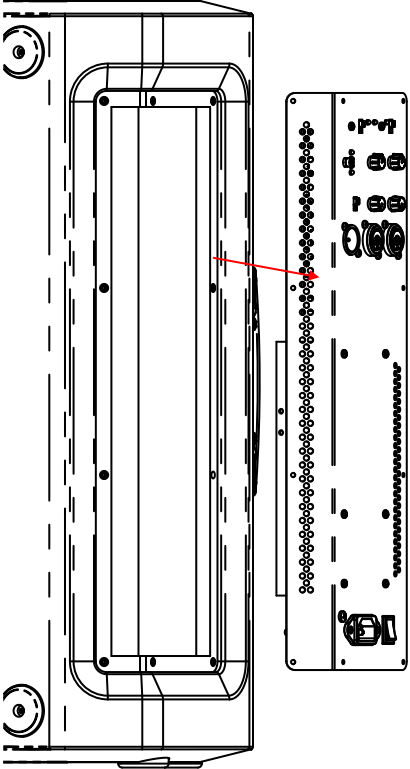

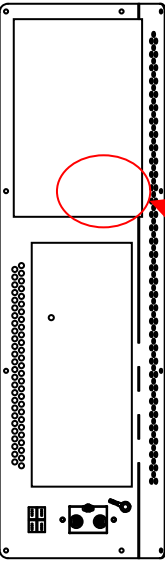

Remove chassis taking care not to apply pressure on speaker cables.

4



HD3 LINK	MUTE DELAY	STANDBY DELAY
PIN 1 & 2	10 MIN.	25 MIN.
PIN 2 & 3	10 MIN.	10 MIN.
NO LINK	2 MIN.	10 MIN.

A  HD3
 (DEFAULT)
 1 2 3

B  HD3 (OPTION SET AT FACTORY)
 (DEFAULT)
 1 2 3

C  HD3
 (DEFAULT)
 1 2 3

Using the jumper, select the required standby mode. Re-assemble the Tessen making sure all screws are fitted before reconnecting power.



SPECIFICATIONS

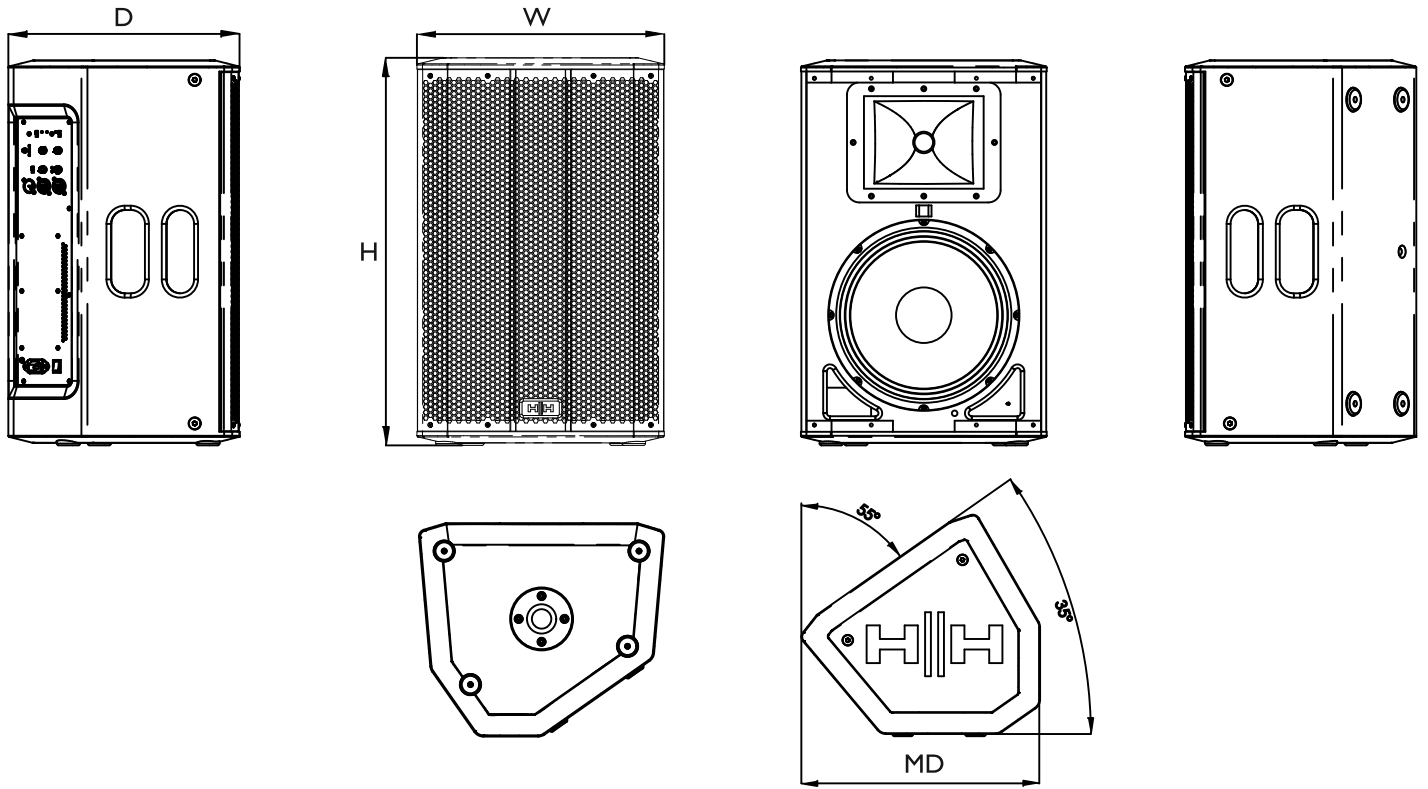

Model	TNX-1201	TNX-1501	TNX-1581
Product type	Loudspeaker		
System type	2 way active speaker		3 way active speaker
Power	2600W		
Amp type (HF)	Class D		
Amp type (LF)	Class D		
Power supply	Switch mode		
DSP	Crossover, EQ, phase and time optimisation		
HF Driver	1.4" Celestion CDX1 compression driver		
Mid Driver	n/a		HH MD-428DN
LF Driver	Celestion TF1225	Celestion TF1525e	Celestion TF1525e HH MD-428DM Mid driver
Frequency response	45 - 20kHz	39 - 20kHz	40 - 20kHz
Max SPL	132dB	133dB	134dB
Coverage	90H x 60V		
Inputs	2 x Balanced jacks/XLR combi inputs		
Outputs	Balanced XLR		
Features	2 x channel gain		
	HF trim		
	LF trim		
	4 x Performance Presets		
	Auto ranging 12 position auto notch anti feedback		
	logo on/off		
	CH1/CH1+CH2 mix switch for line out		
	Signal present indicator		
Protection	Comprehensive protection and clip free limiting + clip indicator		
Flying points	7 x M10 Penn-Elcom fly points		
Pole mount	35mm	35mm	N/A
Cabinet	Lightweight multilayer plywood		
Grille	Heavy gauge steel with acoustic foam backing		
Logo	Illuminating		
Monitor Angle	35°		N/A
Unit dimensions (mm) (HWD)	624x398x375	684x448x390	889x448x390
Monitor depth (mm) (MD)	442	492	N/A
Unit weight (Kg)	20.3	22.9	29.6
Carton dimensions (mm) (HWD)	695x485x470	755x535x480	960x535x480
Packed weight (Kg)	23.6	26.8	33.8

Manufacturer: HH Electronics Ltd.

©2018 HH Electronics Ltd.

May not be reproduced without prior written consent.

In the interest of continued development, HH reserves the right to amend product specification without prior notification.



USEFUL HINTS AND TIPS

- Keep lights away from speakers ; heat can cause fires / speaker damage.
- Don't run cables across access-ways ; if you have to, run them above doors or use approved cable covers.
- Be aware of total power usage. Overloading a mains socket is potentially dangerous, and likely to cause a power out during use.
- Keep lighting cables away from ALL sound including mains, use separate circuit for lights if possible. Keep power and signal cables apart.
- Run all cables neatly, use cable ties to tidy excess cable length in 'figure-8' not loops.
- Use electronic safety devices such as circuit breakers.
- Start with EQ settings flat and gains low. Master volumes should be at zero for switch on and off.
- Use the minimum cut or boost in EQ. If all bands are boosted or cut, flatten EQ, re-adjust gain and start again.
- Use input gain to set maximum signal level without distortion (use VU meters, bar graphs or peak lights). Amps should have peak or clip lights illuminating only on signal peaks, not all the time.
- Set up mic levels first, and adjust other equipment to match.
- Avoid very high onstage levels from back-line amps.
- When using separate power amps, turn the level of the amp to maximum. Control overall level from your mixer, not the amp.
- Avoid damp environments and extremes of temperature for storage and use of all audio equipment.
- Look after your cables. Do not stand equipment or run cases over them, do not tie knots in them and always use them for the correct application (a signal lead is NOT a speaker lead). Coil and secure with cable ties before storing.
- Ensure your equipment is properly loaded and cannot move around during transit.

For an understanding of the Tessens' internal routing, please see the block diagram below.

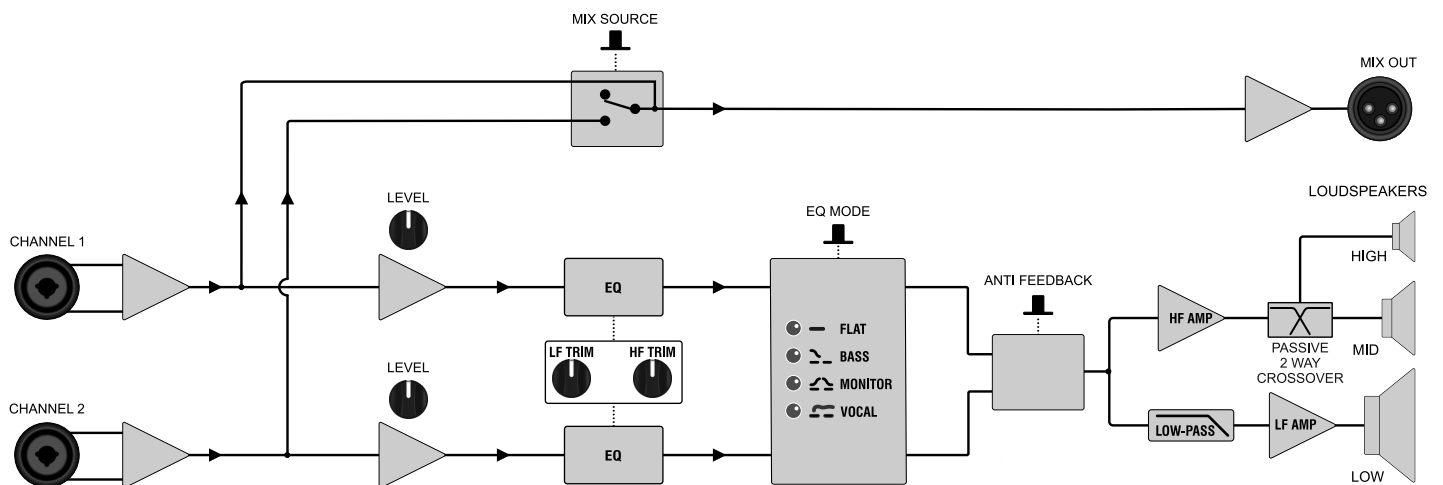

CONNECTOR WIRING

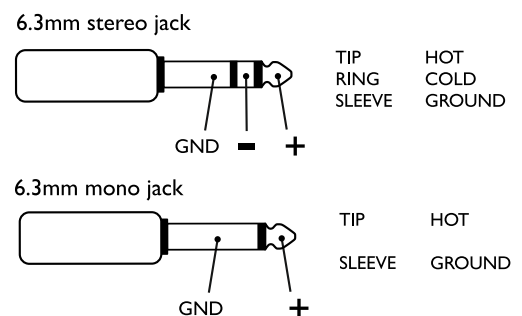
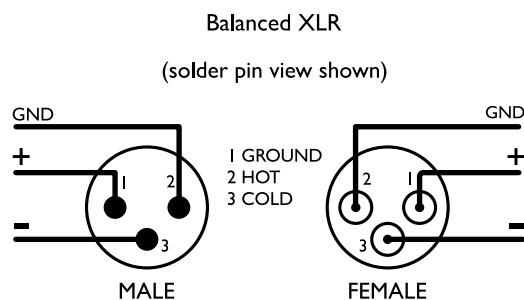

Unbalanced signal cables can be used for interconnects, but are more sensitive to noise pickup, especially over long runs.



TROUBLESHOOTING

Below is a simple trouble shooting guide. Should you have problems in either initial setting up or at some future time, check out the problem by using the following suggestions:

SYMPTOM:

POSSIBLE CAUSE/SOLUTION:

NO SOUND:	Power LED on: Has the volume been set correctly on the Tessen and source device? Are the audio cables correctly seated? Are the audio cables correctly wired? Swap the audio input cable with a known working one.
NO SOUND:	Power LED off: Is the Tessen power and the mains power socket switched on? Is the fuse in the mains IEC cable fitted or has it blown? Swap the power cable with a known working one.
LOW OUTPUT:	Is the channel volume control correctly set? Has the source signal been set to an optimum level? Try a different input cable or source.
LIMITED BASS:	Check that both source signals are in phase, and that cable wiring is correct. Increase LF Trim, or change to Bass setting.
NOISY OUTPUT:	Are channel gains set to their optimum level on all equipment? Is the power source noisy, from a portable generator for example. Are the signal cables damaged? Are the signal cables tangled? Are the signal cables running alongside noisy power or lighting circuits? Are the signal cables inferior quality or unshielded?



TRANSLATIONS



控制面板：TNX-1201 TNX-1501 TNX-1581

1&2 INPUT: 输入:线路电平幅度的兼容平衡和不平衡信号的输入端口,并兼容XLR和6.35插头导线。注意:这些都是平衡信号接口,所以不能直接连接立体声信号使用立体声插头直接输入,必须分成两个单声道插头

GAIN:增益,调整整个设备的输出电平

CLIP:削顶,这个灯点亮表示功放输出级过载或即将过载,然而失真不会发生,因为存在内置限制器。

3. EQUALISATION:均衡器:内置的DSP能提供很多不同的应用程序,4个预设的包含优化音箱响应的设置根据用于需求选择。这些设置能更进一步的通过LF/HF平衡调整。平衡控制可以为你提供微调高音和低音成分。

FLAT:通用的均衡设置

BASS:不仅仅是表面的特征,它调整了很多功放参数来保证得到一个巨大的紧凑的低音。

MONITOR:这个设置提供低音裁剪和中音提升用于舞台

VOCAL:减少低音成分并加强歌声成分。

EQ设定将被存储并导入当电源重启时,出厂设置在FLAT。

4. ANTI-FEEDBACK:自动反馈抑制:这个设置被激活,设备将主动的自动的寻找反馈标记(包含所有音频频率)然后移除它。这个设置是一个高精度陷波器控制反馈但它不会影响你的音乐。一旦设备发现反馈,它将激活陷波器并继续搜索。系统可以寻找和消除12个反馈源,大大降低自激风险。在使用话筒时使用该功能是明智的。

5. POWER MANAGEMENT:电源管理:电源指示灯将点亮当连接一个适当的电源和打开电源开关。

STANDBY:当设备一直保持静止(出厂设置25分钟),此时待机灯将点亮,设备的某些电路将停止工作来节约能源。当任何一个输入检测到信号,功放会唤醒。如果你想更改休眠设置,请全面了解说明书或联系HHE公司。

logo:这个开关将控制网罩上HHE商标点亮或关闭。

6. LINK OUTPUT:环节输出.一个平衡的XLR输出允许设备连接一个附加的主动设备.它的信号来源于输入阶段,可以只选择第一通道信号,也可以选择混合的两通道信号。

7. MAINS INLET IEC:主电源输入端口:一个普通的电源输入端口兼容全球电压.不用改变任何设置除了电源线类型。

8. MAINS SWITCH:电源开关:控制系统的开和关.确保增益控制在最小当你开机和关机时。

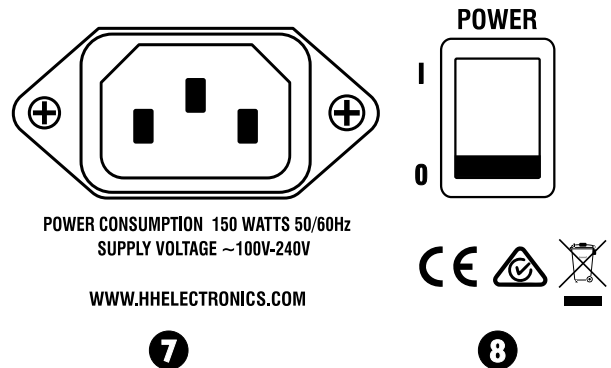
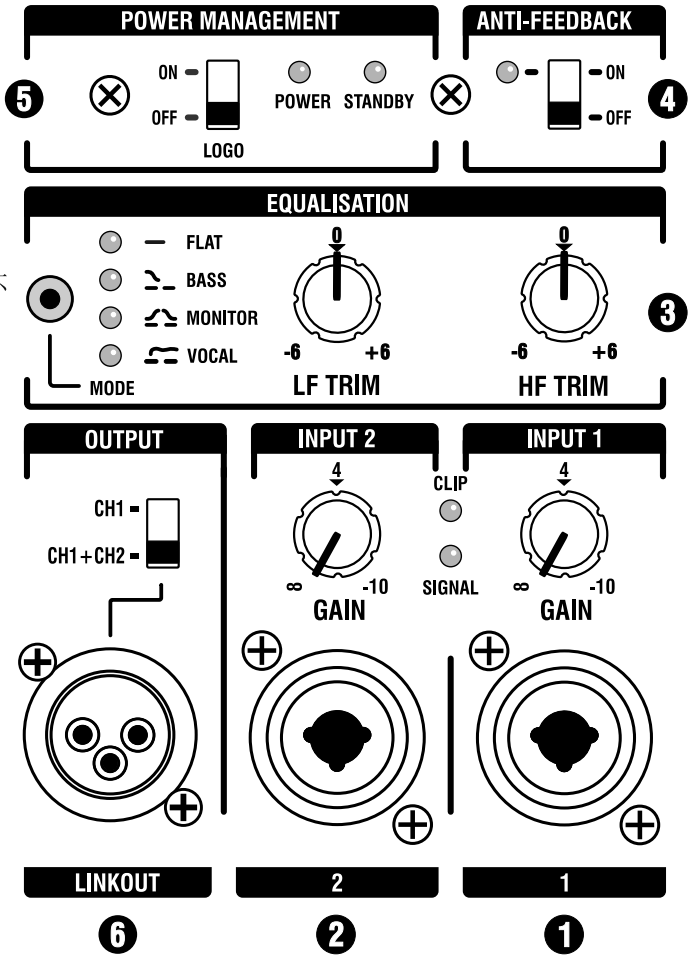

请观察面板上的安全警告信息

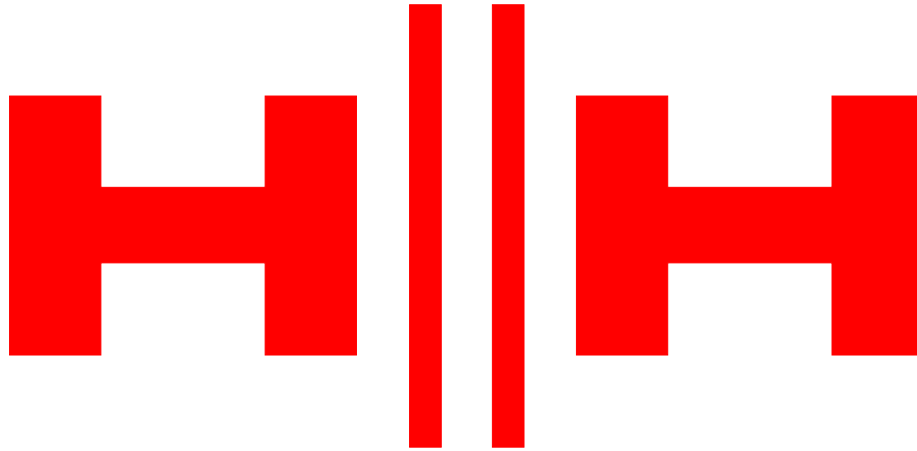

HHELECTRONICS



HHELECTRONICS



HHELECTRONICS



WWW.HHELECTRONICS.COM

Model number:

Serial number:

Place of purchase:

Date of purchase: