

TNE-1501

15" Two-Way Powered Loudspeaker

SPEC SHEET

T E S S E N

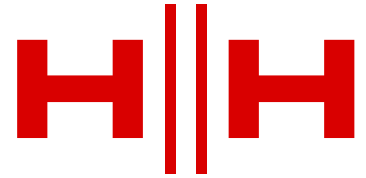

The TNE-1501 is a compact and versatile loudspeaker in the Tessen range. It has been designed to deliver maximum performance for its size and is suitable for front of house PA, stage monitor or install use.

Key Features:

- High sensitivity, long throw HH 15" woofer with Kevlar loaded cone
- High performance, Italian Designed 1" compression driver.
- 1600W asymmetric highly efficient Class D bi-amp
- 3 x M10 fly points for horizontal or vertical suspension
- 35mm pole mount
- 35° monitor angle
- Custom designed DSP engine
- EQ pre-sets for room/application optimisation
- Variable EQ for instant fine tuning for venue/audience size
- Auto-ranging feedback suppression
- Inbuilt 2 channel mixer
- Extensive protection
- Multilayer plywood construction with hardwearing black finish
- 1.5mm steel grille with acoustic foam backing for maximum driver protection
- Frequency range: (-10) 41-20KHz
- Frequency range: (-3) 53-20KHz

Applications:

- Live sound venues
- Dance clubs
- Worship facilities
- Sports facilities
- General sound reinforcement

Control Panel:



System	Model : TNE-1501
	System type : 2 way active 15" loudspeaker, Bass reflex
	Frequency response (-10) : 41 - 20kHz
	Frequency response (-3) : 53 - 20KHz
	Max SPL (Peak) : 129dB
Amplifier	
	Power Rating : 1600W Peak, 800W Continuous
	Input Impedance : 22K Balanced, 10K unbalanced
	Gain : 20dBu
	Maximum Input Level : Mic/Line : 21dBu
	Input Connectors : 2x Balanced Combi XLR/1/4" Jack connectors
	Output Connectors : 1x Balanced XLR output (Switchable CH1/CH1+2)
	Signal Indicators : Power, Standby, Anti-Feedback, Signal Present, Clip Indicator, EQ Mode
	EQ : User selectable performance presets for Flat, Bass, Monitor, Vocal plus HF/LF fine trim.
	DSP : Crossover, EQ, phase and time optimisation
	Protection : Comprehensive protection and clip free limiting + clip indicator
	Feedback Suppression : Auto ranging 12-frequency auto notch anti-feedback
	Other : 2x channel gain, logo on/off
	AC Power : ~100V-240V 50/60Hz
	AC Power Consumption : 100W (1/8th Power)
Speaker	
	HF Driver : 1" LaVoce DF10 compression driver
	LF Driver : 15" HH LG-436EH
	Coverage : 70H x 70V
	Crossover Frequency : 3KHz
Enclosure	
	Cabinet : Lightweight multilayer plywood
	Finish : Hard wearing black finish
	Flying points : 3 x M10 Penn-Elcom fly points
	Pole mount : 35mm
	Grille : Heavy gauge 1.5mm powdercoated steel with acoustic foam backing
	Logo : Illuminating with on/off switch
	Monitor Angle : 35°
	Unit dimensions (mm) (HWD) : 630x433x375
	Monitor depth (mm) (MD) : 466
	Unit weight (Kg) : 19.3
	Carton dimensions (mm) (HWD) : 675x505x445
	Packed weight (Kg) : 22.5

In the interest of continued development, HH reserves the right to amend product specification without prior notification.



Designed and Engineered in the UK by HH Electronics LTD.

TNE-1501

15" Two-Way Powered Loudspeaker

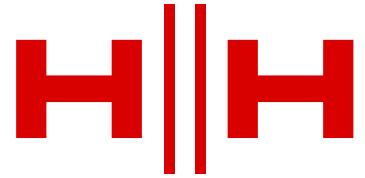

SPEC SHEET

FREQUENCY RESPONSE

Display Parameters: Frequency: (1/3rd Octave) Mer: 0° Par: 0°

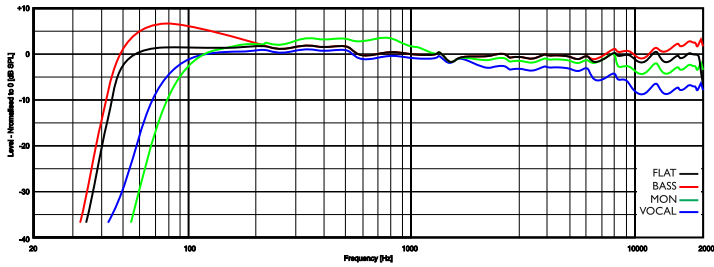

HORIZONTAL OFF-AXIS RESPONSE

Data Shown: TNE-1501 (HH Electronics) Resolution: High Res. Mer 30° Par 5° Symmetry: Horizontal
Display Parameters: Frequency: 1000Hz (1/3rd Octave) Mer: 0° Par: 0°

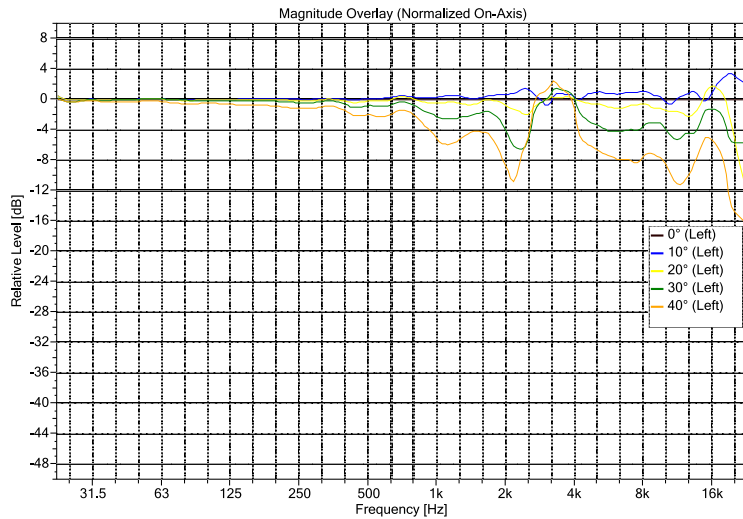

VERTICAL OFF-AXIS RESPONSE

Data Shown: TNE-1501 (HH Electronics) Resolution: High Res. Mer 30° Par 5° Symmetry: Horizontal
Display Parameters: Frequency: 1000Hz (1/3rd Octave) Mer: 0° Par: 0°

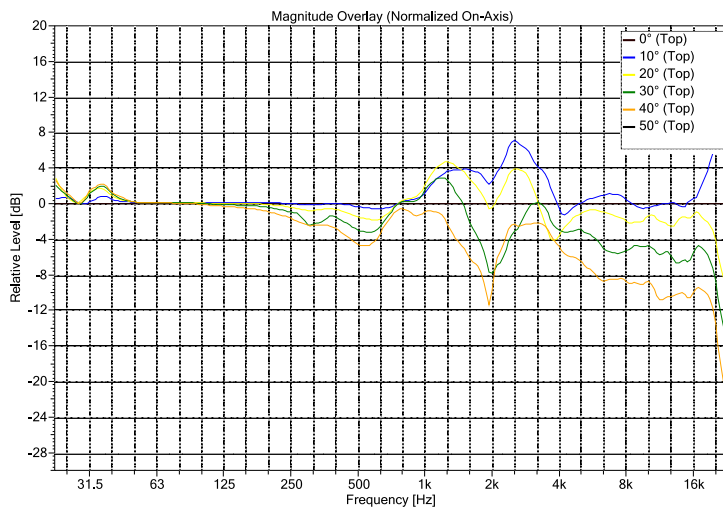

Designed and Engineered in the UK by HH Electronics LTD.

TNE-1501

15" Two-Way Powered Loudspeaker

T E S S E N

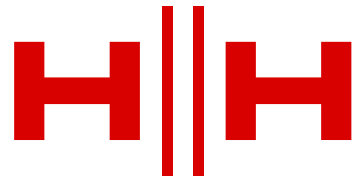

SPEC SHEET

Data Show: TNE-1501 (HH Electronics) Resolution: High Res, Mer 30° Par 5° Symmetry: Horizontal
 Display Parameters: Frequency: 500Hz (1/3rd Octave)

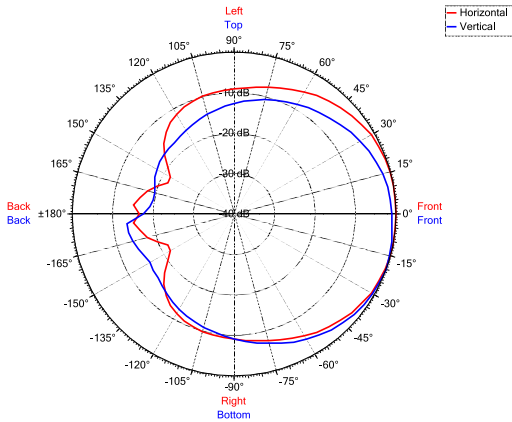

Data Show: TNE-1501 (HH Electronics) Resolution: High Res, Mer 30° Par 5° Symmetry: Horizontal
 Display Parameters: Frequency: 630Hz (1/3rd Octave)

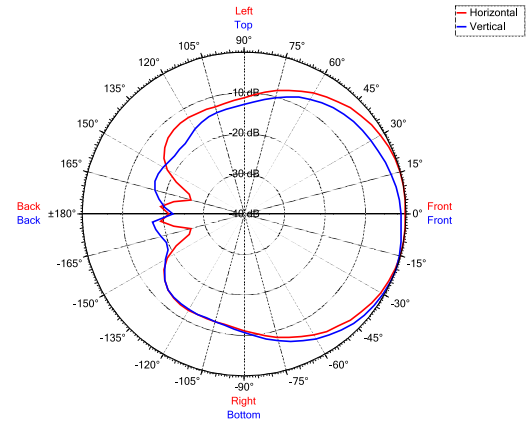

Data Show: TNE-1501 (HH Electronics) Resolution: High Res, Mer 30° Par 5° Symmetry: Horizontal
 Display Parameters: Frequency: 800Hz (1/3rd Octave)

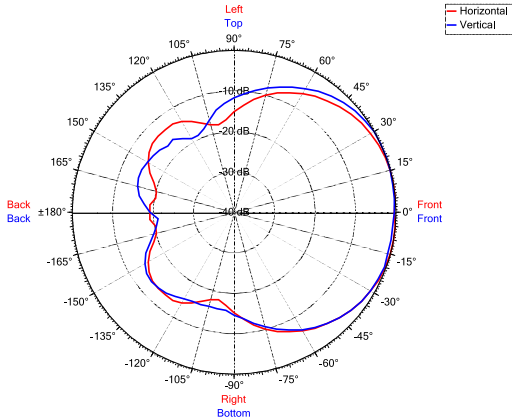

Data Show: TNE-1501 (HH Electronics) Resolution: High Res, Mer 30° Par 5° Symmetry: Horizontal
 Display Parameters: Frequency: 1000Hz (1/3rd Octave)

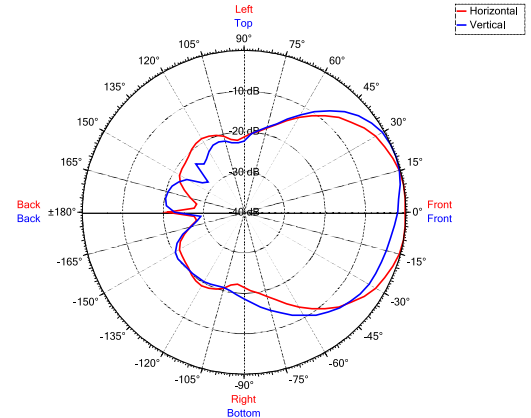

Data Show: TNE-1501 (HH Electronics) Resolution: High Res, Mer 30° Par 5° Symmetry: Horizontal
 Display Parameters: Frequency: 1250Hz (1/3rd Octave)

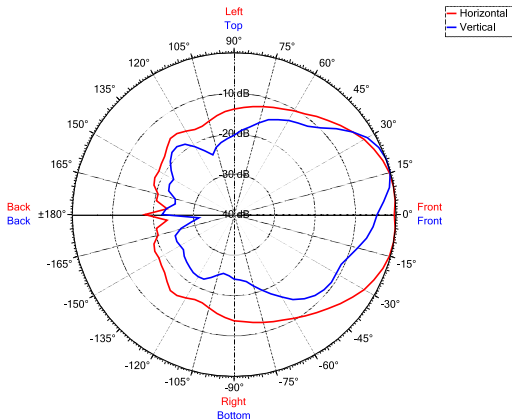

Data Show: TNE-1501 (HH Electronics) Resolution: High Res, Mer 30° Par 5° Symmetry: Horizontal
 Display Parameters: Frequency: 1600Hz (1/3rd Octave)

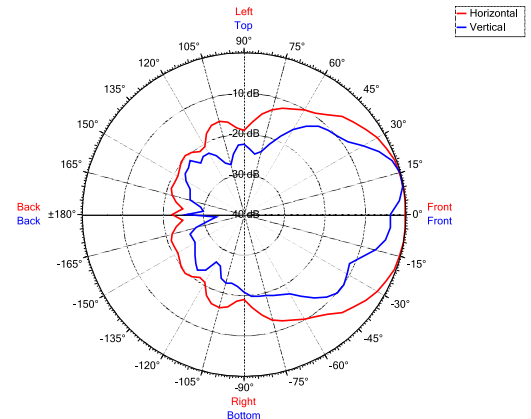

Data Show: TNE-1501 (HH Electronics) Resolution: High Res, Mer 30° Par 5° Symmetry: Horizontal
 Display Parameters: Frequency: 2000Hz (1/3rd Octave)

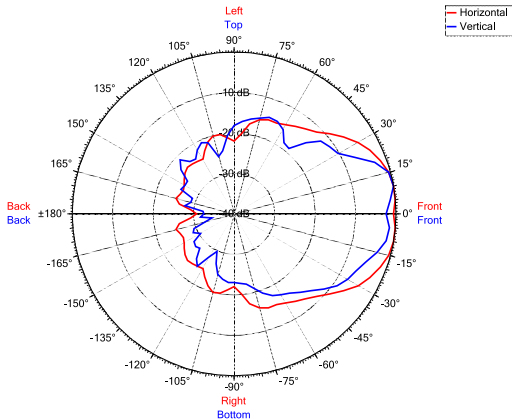

Data Show: TNE-1501 (HH Electronics) Resolution: High Res, Mer 30° Par 5° Symmetry: Horizontal
 Display Parameters: Frequency: 2500Hz (1/3rd Octave)

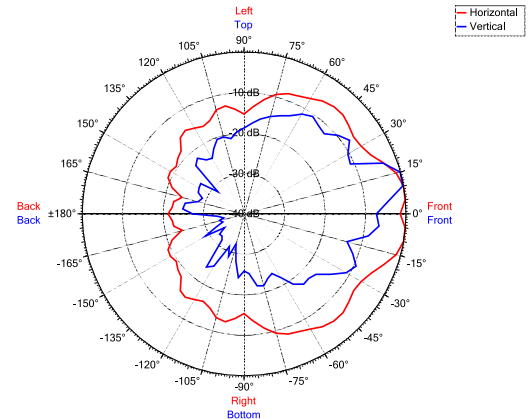

Designed and Engineered in the UK by HH Electronics LTD.

TNE-1501

15" Two-Way Powered Loudspeaker

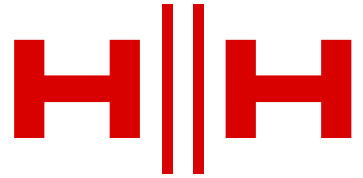

SPEC SHEET

Data Shown: TNE-1501 (HH Electronics) Resolution: High Res. Mer 30° Par 5° Symmetry: Horizontal
 Display Parameters: Frequency: 3150Hz (1/3rd Octave)

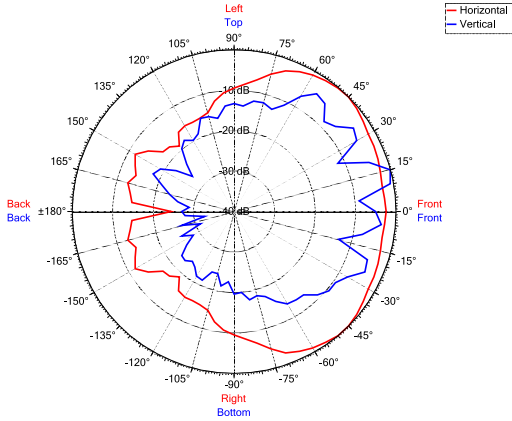

Data Shown: TNE-1501 (HH Electronics) Resolution: High Res. Mer 30° Par 5° Symmetry: Horizontal
 Display Parameters: Frequency: 4000Hz (1/3rd Octave)

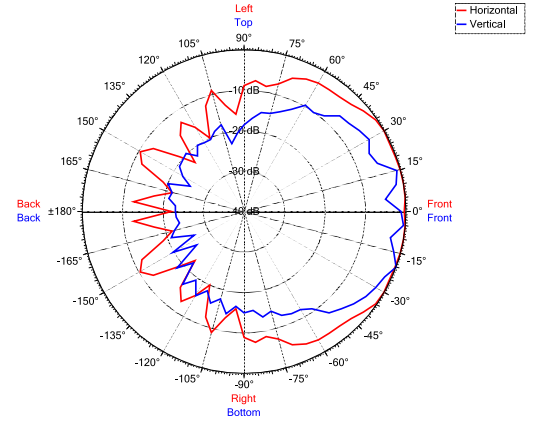

Data Shown: TNE-1501 (HH Electronics) Resolution: High Res. Mer 30° Par 5° Symmetry: Horizontal
 Display Parameters: Frequency: 5000Hz (1/3rd Octave)

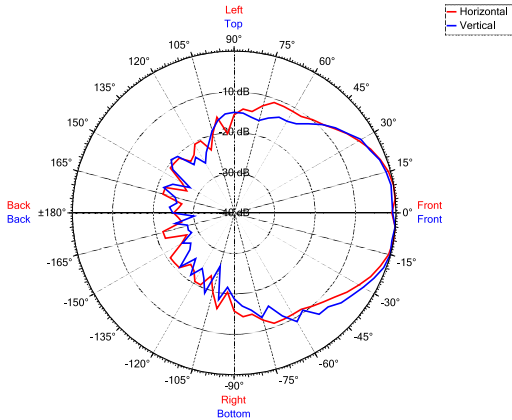

Data Shown: TNE-1501 (HH Electronics) Resolution: High Res. Mer 30° Par 5° Symmetry: Horizontal
 Display Parameters: Frequency: 6300Hz (1/3rd Octave)

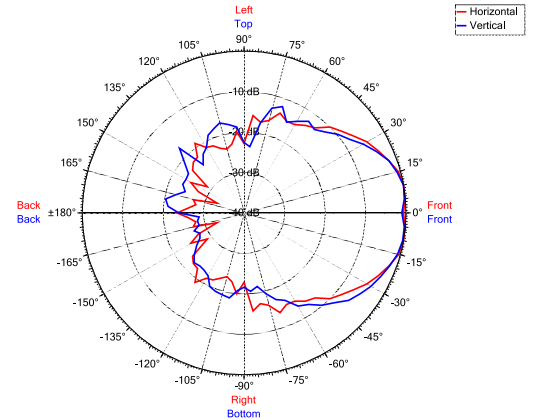

Data Shown: TNE-1501 (HH Electronics) Resolution: High Res. Mer 30° Par 5° Symmetry: Horizontal
 Display Parameters: Frequency: 8000Hz (1/3rd Octave)

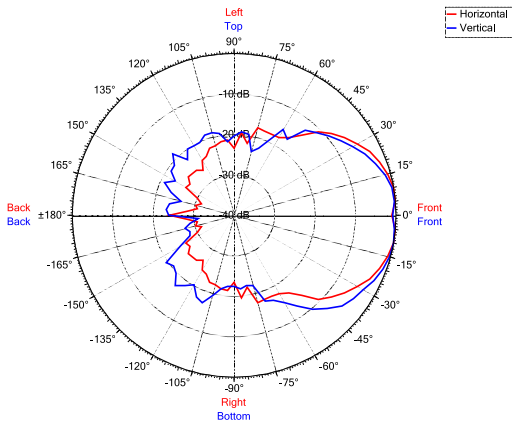

Data Shown: TNE-1501 (HH Electronics) Resolution: High Res. Mer 30° Par 5° Symmetry: Horizontal
 Display Parameters: Frequency: 10000Hz (1/3rd Octave)

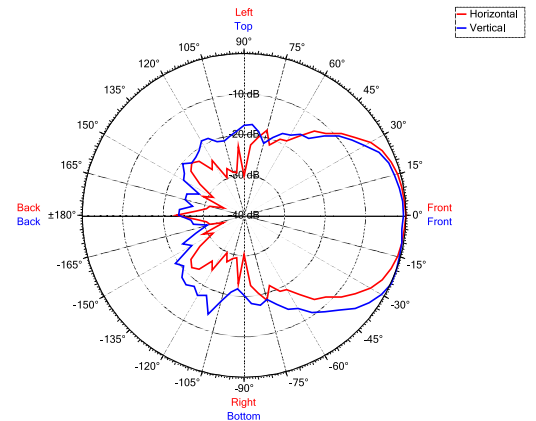

Data Shown: TNE-1501 (HH Electronics) Resolution: High Res. Mer 30° Par 5° Symmetry: Horizontal
 Display Parameters: Frequency: 12500Hz (1/3rd Octave)

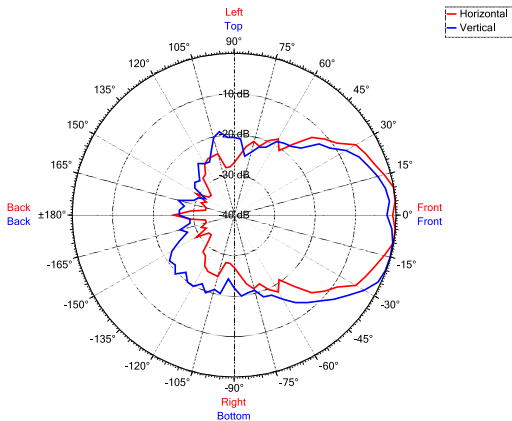

Data Shown: TNE-1501 (HH Electronics) Resolution: High Res. Mer 30° Par 5° Symmetry: Horizontal
 Display Parameters: Frequency: 16000Hz (1/3rd Octave)

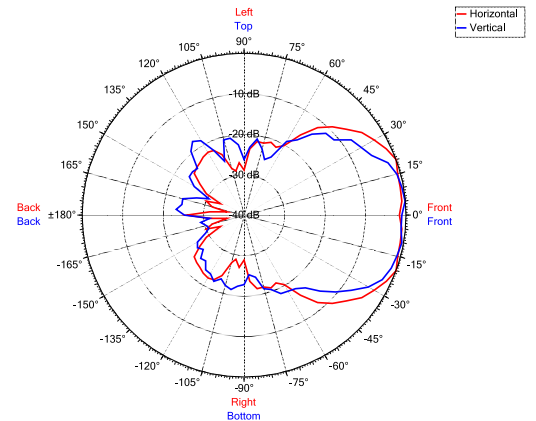

Designed and Engineered in the UK by HH Electronics LTD.

TNE-1501

15" Two-Way Powered Loudspeaker

TESSEN

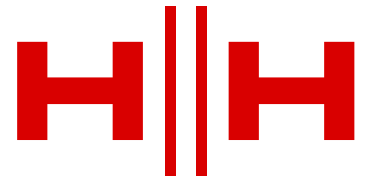

SPEC SHEET

BLOCK DIAGRAM

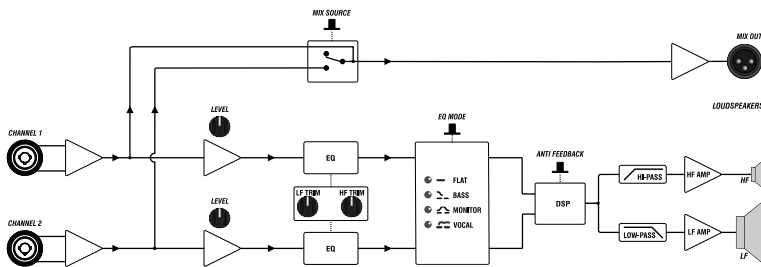

DIMENSIONS (in mm)

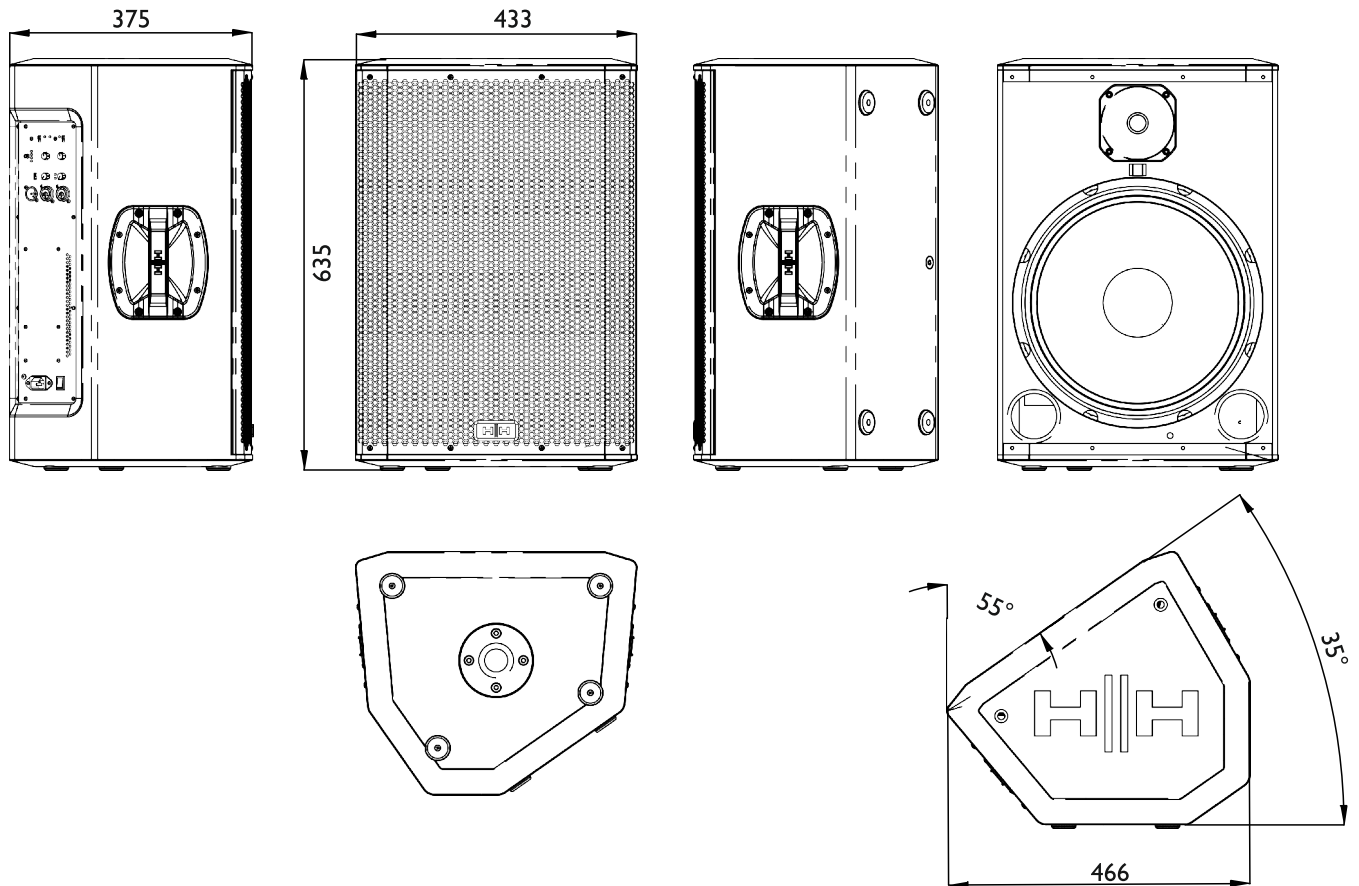

For additional polar plots, EASE modelling files, 2D and 3D drawings files, please check www.hhelectronics.com



Designed and Engineered in the UK by HH Electronics LTD.