

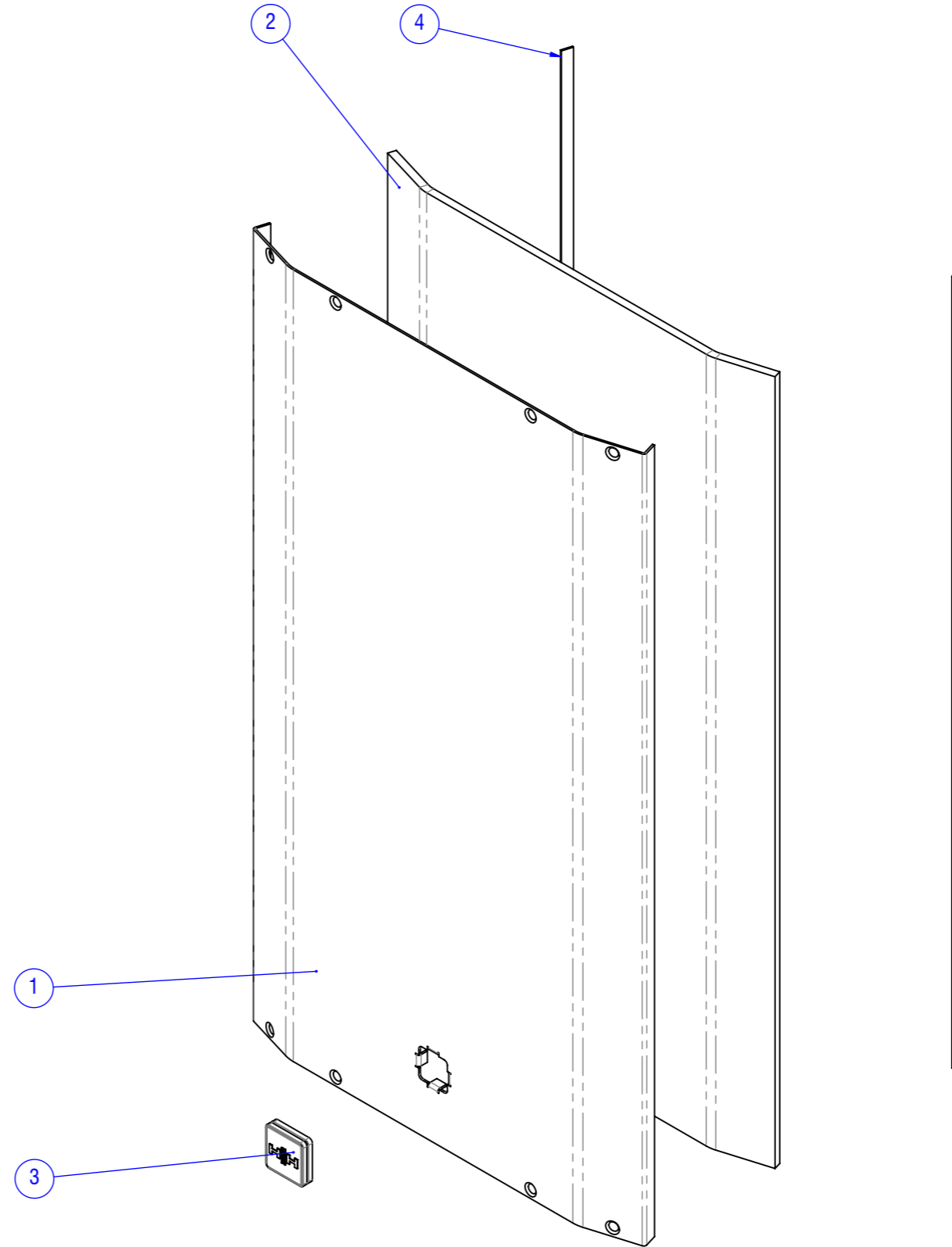

ITEM NO.	Part Number	DESCRIPTION	Revision	QTY.
1	MCM016384	Grille MCM016383 - Finished Black	1	1
2	MCM016386	Grille - Foam	1	1
3	MCA015401	HH Rotating Badge (Black & Silver)	2	1
4	MCM016387	Grille - Gasket (492mm x 7mm x 1mm)	1	2



 HH ELECTRONICS LTD STEELPARK ROAD, COOMBS WOOD BUSINESS PARK, HALESOWEN, WEST MIDLANDS, B62 8HD, UK WWW.HHELECTRONICS.CO.UK	DESCRIPTION: GRILLE ASSEMBLY - BLACK	PROJECT TITLE: TNI-W10PRO	DWG NO. MCA016376	REVISION: 1
	STATE: RELEASED	REFER TO 3D MODEL FOR FULL DIMENSIONAL DATA	DATE: 12/07/2023	RELEASED BY: TB
	 UNLESS OTHERWISE STATED: ALL DIMENSIONS ARE IN MILLIMETERS (mm) LINEAR TOLERANCE ± 0.5 ANGULAR TOLERANCE $\pm 1.0^\circ$	THIS DRAWING REMAINS THE PROPERTY OF HH ELECTRONICS LIMITED. THIS DRAWING, HARD COPY OR DIGITAL, AND ANY ATTACHMENTS ARE CONFIDENTIAL, LEGALLY PRIVILEGED AND PROTECTED BY COPYRIGHT.	SCALE: 1:3	SHEET SIZE: A3

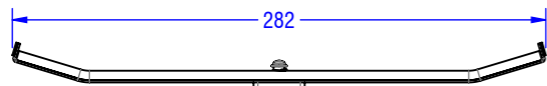

TOP

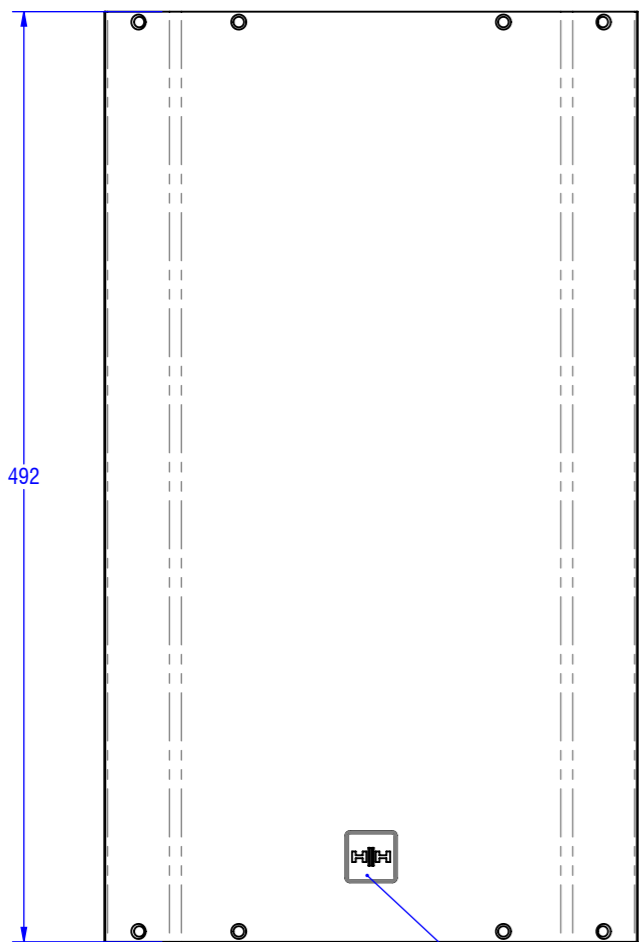

FRONT

ROTATING
BADGE



24.5

RIGHT

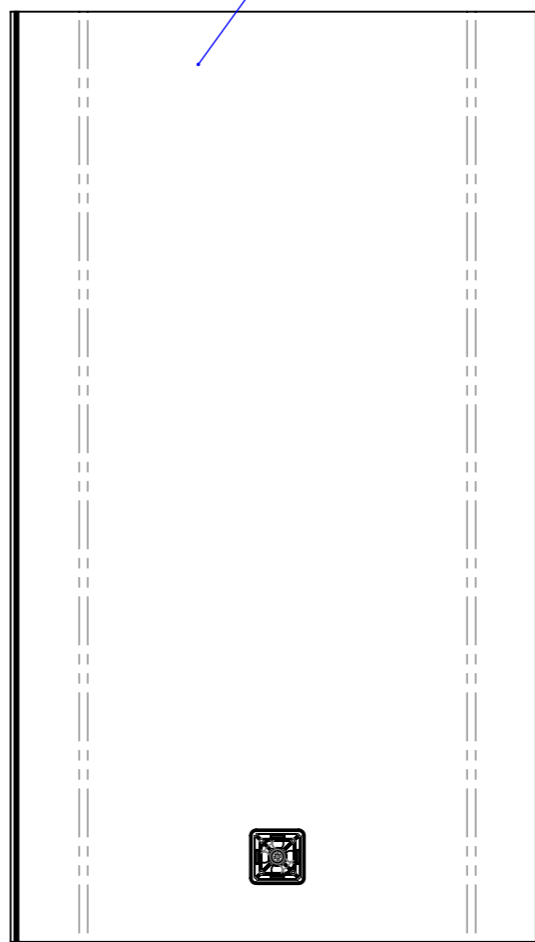

REAR

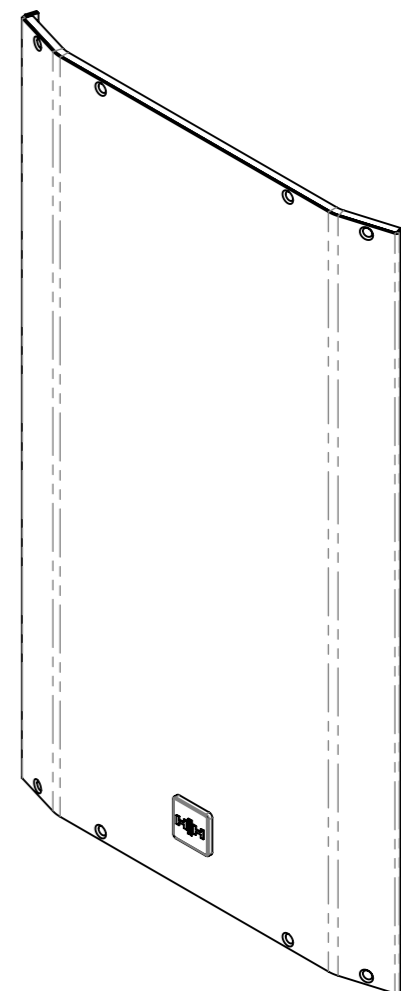

GLUE FOAM TO BACK OF GRILLE





GASKET ON
EDGE OF
GRILLE



HH ELECTRONICS LTD
STEELPARK ROAD, COOMBS WOOD BUSINESS PARK,
HALESOWEN, WEST MIDLANDS, B62 8HD, UK
WWW.HHELECTRONICS.CO.UK

DESCRIPTION: GRILLE ASSEMBLY - BLACK	PROJECT TITLE: TNI-W10PRO	DWG NO. MCA016376	REVISION: 1
STATE: RELEASED	REFER TO 3D MODEL FOR FULL DIMENSIONAL DATA	DATE: 12/07/2023	RELEASED BY: TB
  UNLESS OTHERWISE STATED: ALL DIMENSIONS ARE IN MILLIMETERS (mm) LINEAR TOLERANCE ± 0.5 ANGULAR TOLERANCE $\pm 1.0^\circ$	THIS DRAWING REMAINS THE PROPERTY OF HH ELECTRONICS LIMITED. THIS DRAWING, HARD COPY OR DIGITAL, AND ANY ATTACHMENTS ARE CONFIDENTIAL, LEGALLY PRIVILEGED AND PROTECTED BY COPYRIGHT.		SCALE: 1:4
		SHEET SIZE: A3	SHEET: 2/2

DESCRIPTION: GRILLE ASSEMBLY - BLACK	PROJECT TITLE: TNI-W10PRO	DWG NO. MCA016376	REVISION: 1
STATE: RELEASED	REFER TO 3D MODEL FOR FULL DIMENSIONAL DATA	DATE: 12/07/2023	RELEASED BY: TB
  UNLESS OTHERWISE STATED: ALL DIMENSIONS ARE IN MILLIMETERS (mm) LINEAR TOLERANCE ± 0.5 ANGULAR TOLERANCE $\pm 1.0^\circ$	THIS DRAWING REMAINS THE PROPERTY OF HH ELECTRONICS LIMITED. THIS DRAWING, HARD COPY OR DIGITAL, AND ANY ATTACHMENTS ARE CONFIDENTIAL, LEGALLY PRIVILEGED AND PROTECTED BY COPYRIGHT.		SCALE: 1:4
		SHEET SIZE: A3	SHEET: 2/2