

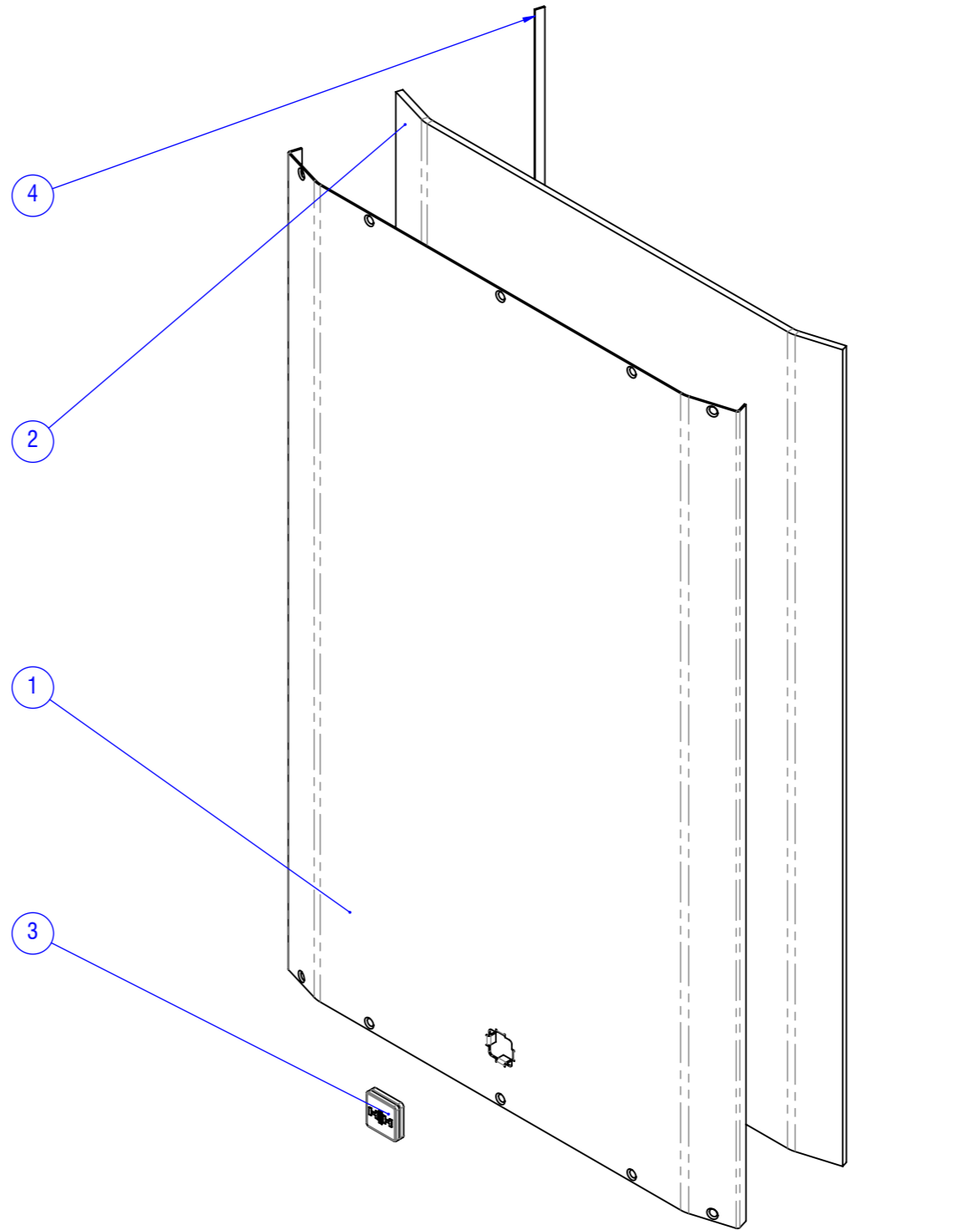



ITEM NO.	Part Number	DESCRIPTION	Revision	QTY.
1	MCM016407	MCM016406 - Finished Black	1	1
2	MCM016409	Grille - Foam	1	1
3	MCA015401	HH Rotating Badge (Black & Silver)	2	1
4	MCM016410	Grille - Gasket (633mm x 7mm x 1mm)	1	2



 HH ELECTRONICS LTD STEELPARK ROAD, COOMBS WOOD BUSINESS PARK, HALESOWEN, WEST MIDLANDS, B62 8HD, UK WWW.HHELECTRONICS.CO.UK	DESCRIPTION: GRILLE ASSEMBLY - BLACK	PROJECT TITLE: TNI-W15PRO	DWG NO. MCA016404	REVISION: 1
	STATE: RELEASED	REFER TO 3D MODEL FOR FULL DIMENSIONAL DATA	DATE: 13/07/2023	RELEASED BY: TB
	 UNLESS OTHERWISE STATED: ALL DIMENSIONS ARE IN MILLIMETERS (mm) LINEAR TOLERANCE ± 0.5 ANGULAR TOLERANCE $\pm 1.0^\circ$	THIS DRAWING REMAINS THE PROPERTY OF HH ELECTRONICS LIMITED. THIS DRAWING, HARD COPY OR DIGITAL, AND ANY ATTACHMENTS ARE CONFIDENTIAL, LEGALLY PRIVILEGED AND PROTECTED BY COPYRIGHT.	SCALE: 1:4	SHEET SIZE: A3

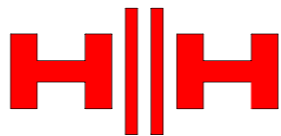
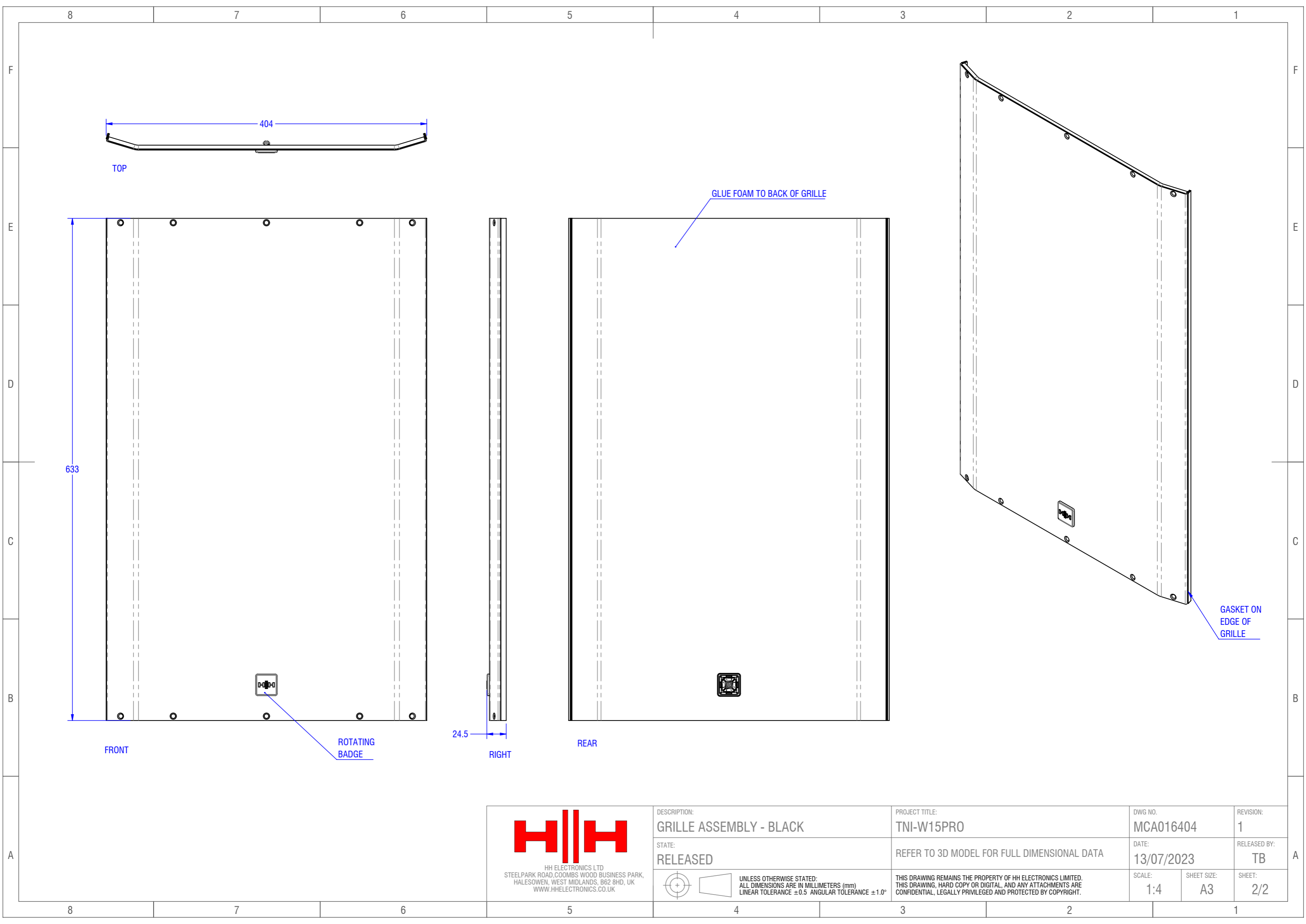

HH ELECTRONICS LTD
 STEELPARK ROAD, COOMBS WOOD BUSINESS PARK,
 HALESOWEN, WEST MIDLANDS, B62 8HD, UK
 WWW.HHELECTRONICS.CO.UK

DESCRIPTION: GRILLE ASSEMBLY - BLACK	PROJECT TITLE: TNI-W15PRO	DWG NO. MCA016404	REVISION: 1
STATE: RELEASED	REFER TO 3D MODEL FOR FULL DIMENSIONAL DATA	DATE: 13/07/2023	RELEASED BY: TB
  UNLESS OTHERWISE STATED: ALL DIMENSIONS ARE IN MILLIMETERS (mm) LINEAR TOLERANCE ± 0.5 ANGULAR TOLERANCE $\pm 1.0^\circ$	THIS DRAWING REMAINS THE PROPERTY OF HH ELECTRONICS LIMITED. THIS DRAWING, HARD COPY OR DIGITAL, AND ANY ATTACHMENTS ARE CONFIDENTIAL, LEGALLY PRIVILEGED AND PROTECTED BY COPYRIGHT.		

SCALE: 1:4	SHEET SIZE: A3	SHEET: 2/2
----------------------	--------------------------	----------------------