

TNi-W10PRO

2-WAY FULL RANGE PASSIVE LOUDSPEAKER, 10" LF, BASS REFLEX

FEATURES

- 10" HH-Designed High Performance LF Driver, 1.4" Celestion CDX1-1445 HF Driver
- Custom Designed Rotatable Waveguide for Vertical or Horizontal Orientation
- 90° x 60° Dispersion Angle
- Frequency Response: 56Hz - 20 kHz (-10 dB)
- 126 dB Max SPL (Peak)
- Robust 15mm Plywood Cabinet. Powder Coated Steel Grille with Acoustic Foam Backing.

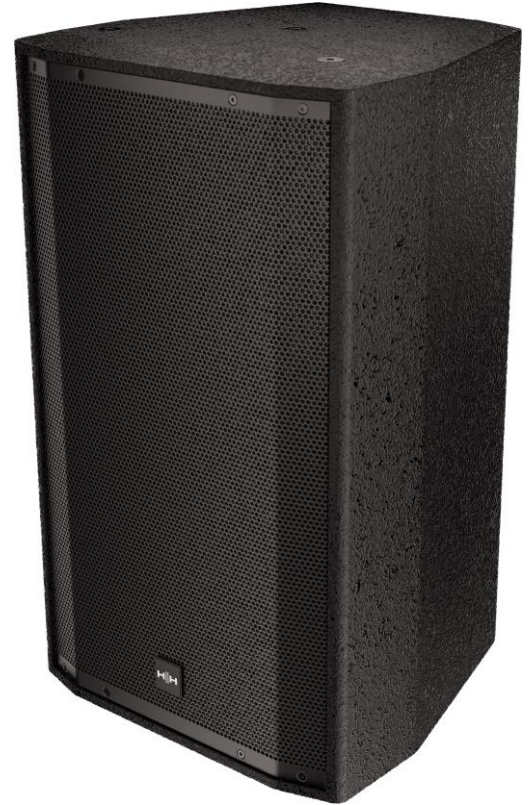

INPUT PANEL

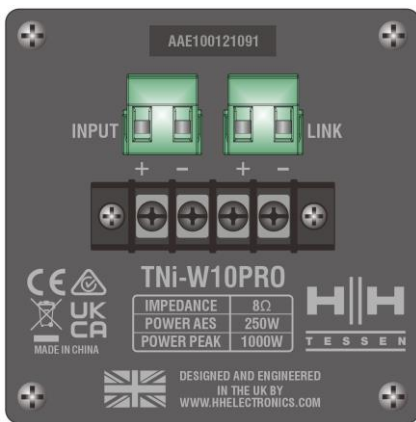

APPLICATIONS

- Bars and Clubs
- Live Sound Reinforcement
- Restaurants
- Ballrooms
- Corporate AV and Conferences
- Main PA infill
- Secondary Stages
- Houses of Worship
- Leisure Centres and Retail

DESCRIPTION

The TNi-W10Pro is a high-power, 2-way, full-range loudspeaker system that comprises a HH-designed 10-inch low-frequency driver with a 2-inch voice coil alongside a 1.4-inch Celestion CDX1-1445 high-frequency compression driver.

The TNi-W10PRO features a rotatable waveguide designed in collaboration with Celestion, which provides a 90°(H) x 60°(V) dispersion angle and enables the unit to be installed in either a vertical or horizontal orientation.

Mounting options include 4 x M8 mounting points for using the optional TNi-BRK30 multi-angle wall bracket as well as 7 x M10 Penn-Elcom fly points. The recessed rear panel offers flexible input connections via either Euroblock or M4 barrier strip.

The robust enclosure is composed of 15mm plywood coated with a hard-wearing spatter finish plus a powder-coated steel grille with acoustic foam backing. Available in black or white.

ARCHITECT'S/ENGINEER'S SPECIFICATION

The loudspeaker cabinet shall be a 10" 2-way rear ported system.

The cabinet shall be a robust all-wood construction using 15mm plywood with a hard-wearing spatter finish. The front of the cabinet shall be finished with a powder-coated steel grille, lined with an acoustic foam backing.

The cabinet shall provide a total of 7 x M10 Penn-Elcom fly points to be compatible with the TNi-BRK30 mounting bracket. 3 on the top face, 2 on the side face, 1 on the rear, and 1 on the bottom of the cabinet.

The loudspeaker cabinet shall have an AES power handling of 250W with a peak power handling of 1000W. The frequency response shall be from 56- 20kHz (-10dB). The sensitivity shall be 98dB when measuring with an input signal of 1 watt at a distance of 1 meter. The maximum continuous sound pressure level shall reach 125 dB.

The loudspeaker shall consist of a 1.4" Celestion CDX1-1445 HF driver and a 10" HH Designed High-Performance LF driver with a 2" voice coil. The rated impedance shall be 8 ohms. The horn on the HF driver shall be rotatable and have a horizontal dispersion angle of 90° and a vertical dispersion angle of 60°.

Connections with the speaker shall be made using a Euroblock Connector or M4 Barrier Strip Terminal (7.62mm Pitch).

The loudspeaker cabinet shall not exceed a height of 524mm, a width of 308mm, and a depth of 297mm. The weight of the loudspeaker shall not exceed 12.4 kg.



Specifications	
Model	TNi-W10PRO
System type	2-Way Full Range Passive Loudspeaker, 10" LF, Bass Reflex
Woofer Size	10" Black 25050-8 HH Designed High Performance Driver, 2.0" Voice Coil
Tweeter Size	1.4" Celestion CDX1-1445
Nominal System Impedance	8 ohm
Power Rating ¹	250W AES, 500W Continuous, 1000W Peak
Recommended Amplifier	HH M-Series M-750D or M-1500D or equivalent with 500-1000W @ 8 Ohms
Sensitivity 1W/1m ²	95 dB SPL
Maximum SPL (1m) ³	119 dB SPL, 125 dB SPL (Peak)
Frequency response	56 - 20kHz (-10dB)
	66 - 18kHz (-3dB)
Input / Link Connector	Euroblock Connector and M4 Barrier Strip Terminal (7.62mm Pitch)
Horizontal Dispersion Angle	90°
Vertical Dispersion Angle	60°
Crossover Frequency	2.2KHz
Enclosure	
Main Construction Material	Robust all wood construction (15mm plywood)
Finish	Hard wearing spatter finish (White or Black option)
Grille	Powdercoated steel with acoustic foam backing
Mounting Bracket	4x M8 mounting points for optional HH-BRK30
Mounting Suspension Points	7x M10 Penn-Elcom fly points (3 on top face, 2 on side face, 1 on rear, 1 on bottom)
Unit dimensions (HWD)	524 x 308 x 297mm, 20.6" x 12.1" x 11.7"
Unit weight	13.2Kg, 29.1 lbs
Carton dimensions (HWD)	665 x 435 x 425mm, 26.2" x 17.1" x 16.7", 0.123 M3
Packed weight	14.8Kg, 32.6 lbs
EAN Code	5060109458954 (Black), 5060109458947 (White)
Optional Accessories	TNi-BRK30 High Quality Multi Angle Wall Bracket



FREQUENCY RESPONSE

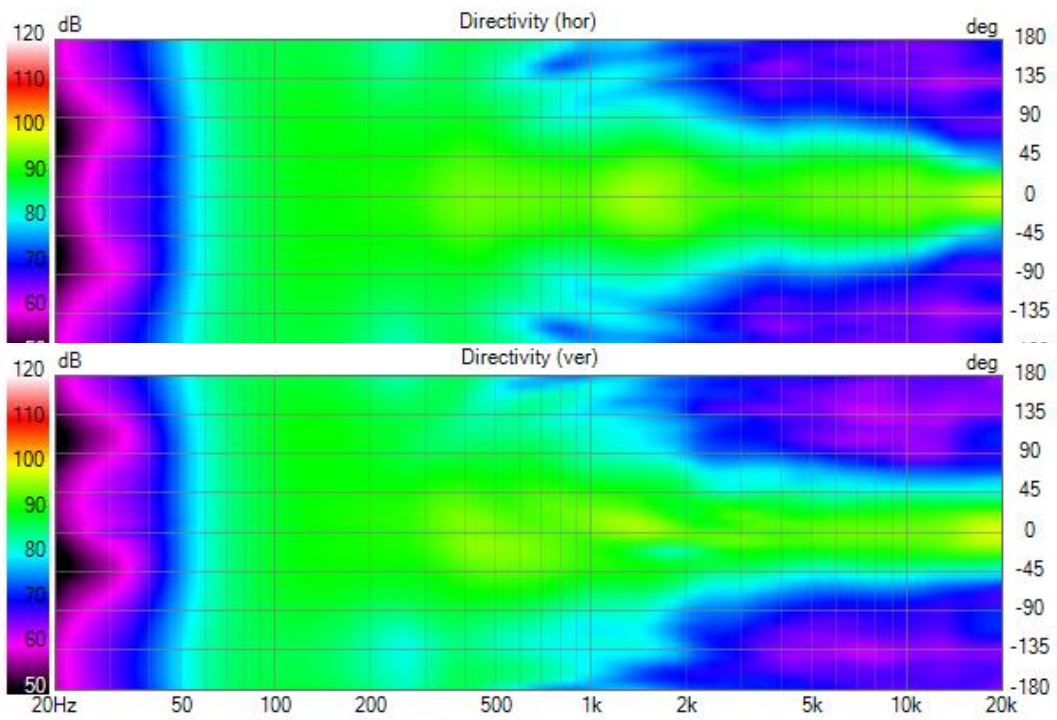
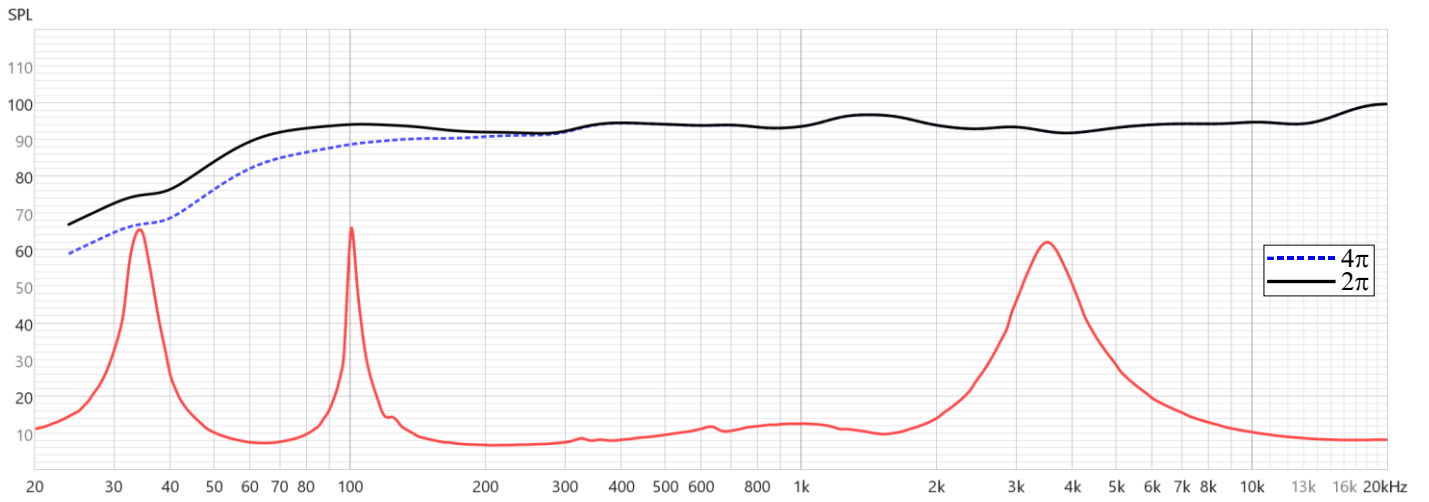



Hor. 125 Hz, DI=3.1 dB

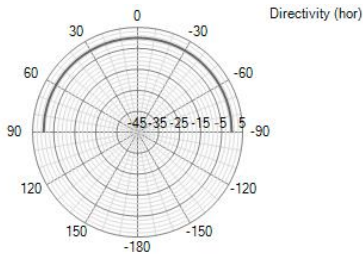

Ver. 125 Hz, DI=3.1 dB

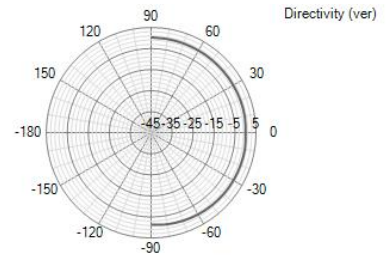

Hor. 250 Hz, DI=4.5 dB

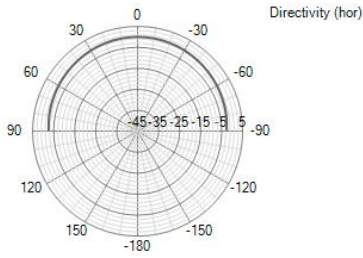

Ver. 250 Hz, DI=4.5 dB

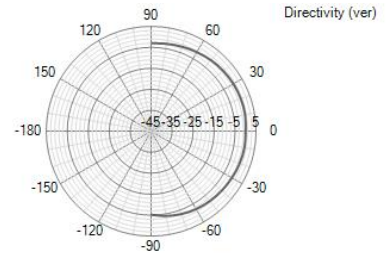

Hor. 501 Hz, DI=6.0 dB

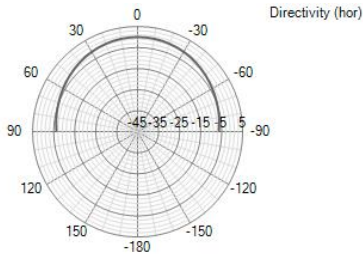

Ver. 501 Hz, DI=6.0 dB

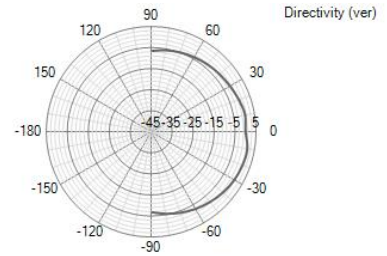

Hor. 1001 Hz, DI=7.1 dB

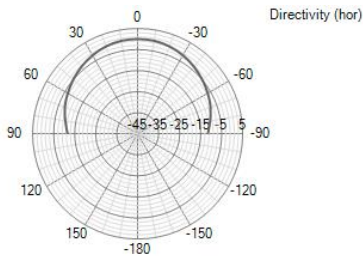

Ver. 1001 Hz, DI=7.1 dB

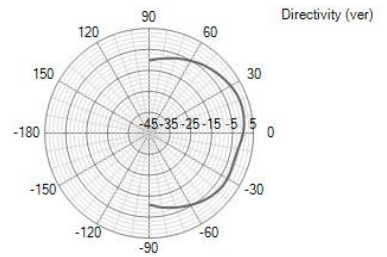

Hor. 2003 Hz, DI=8.8 dB

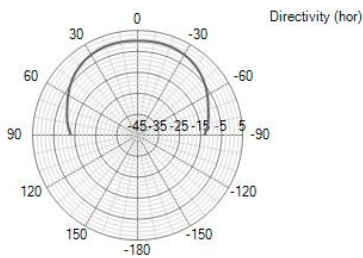

Ver. 2003 Hz, DI=8.8 dB

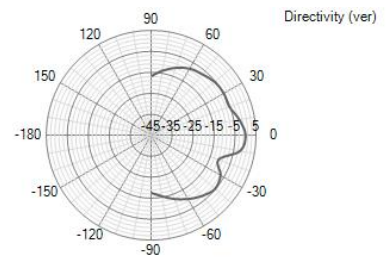

Hor. 4005 Hz, DI=10.0 dB

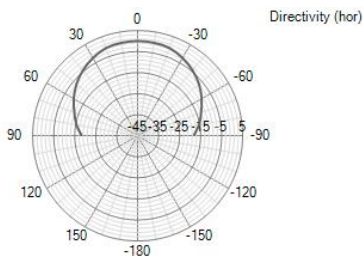

Ver. 4005 Hz, DI=10.0 dB

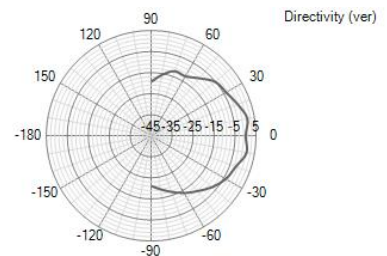

Hor. 8011 Hz, DI=10.5 dB

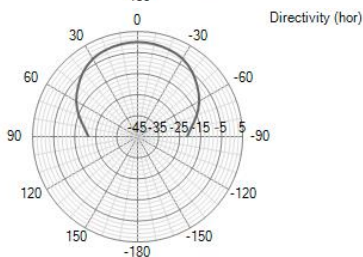

Ver. 8011 Hz, DI=10.5 dB

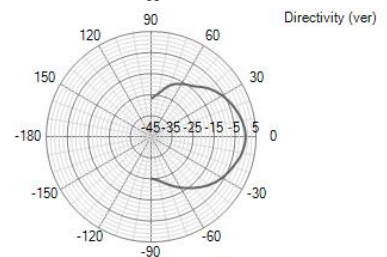

DIMENSIONS

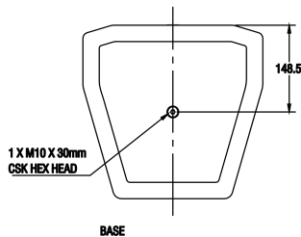
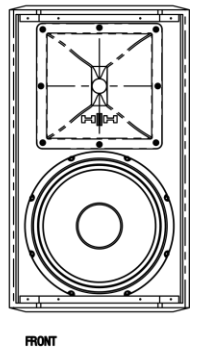
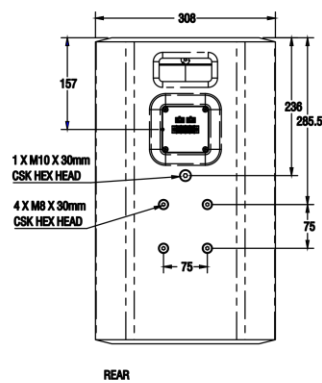
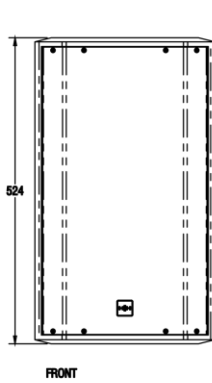
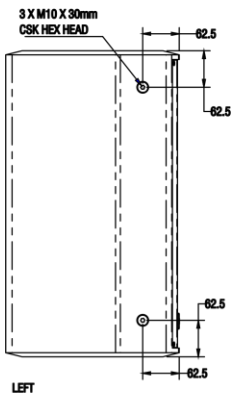
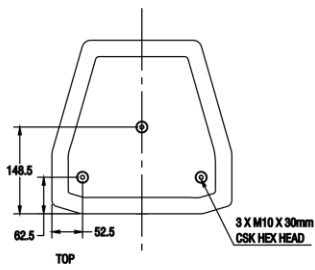
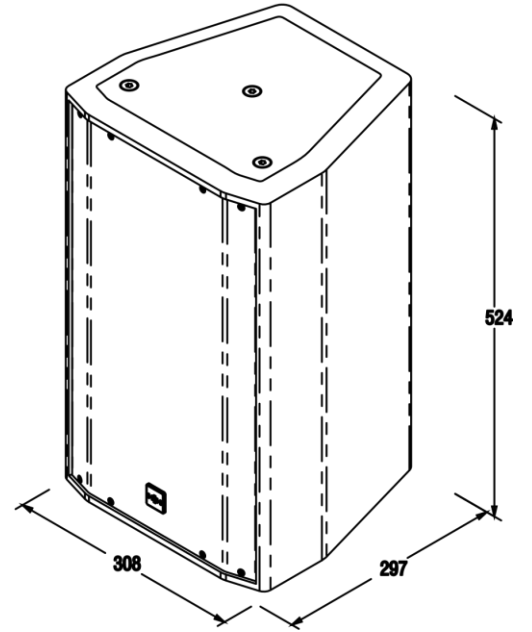
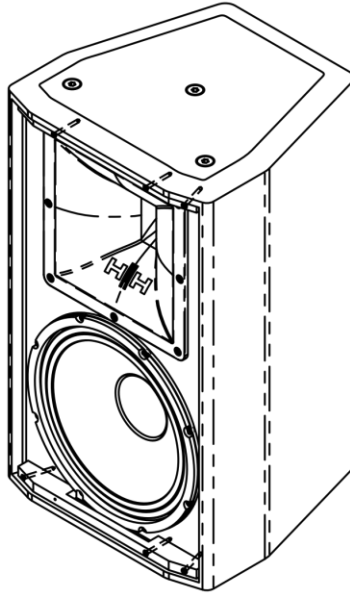
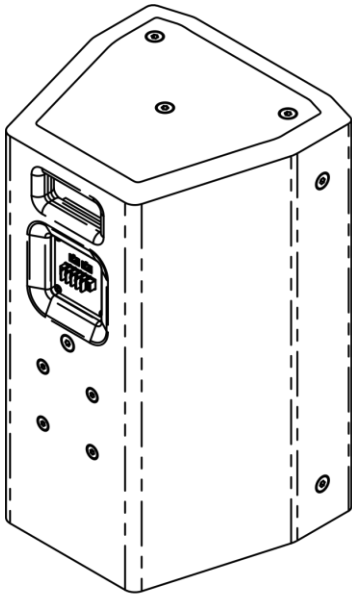

HH Electronics is a trading style of
Headstock Distribution Ltd,
Steelpark Road, Coombswood Business Park West,
Halesowen, West Midlands, B62 8HD, UK.
© 2024 HH Electronics Ltd
www.hhaudio.com

In the interest of continued development, HH reserves the right to amend product specification without prior notification.

