

TOP

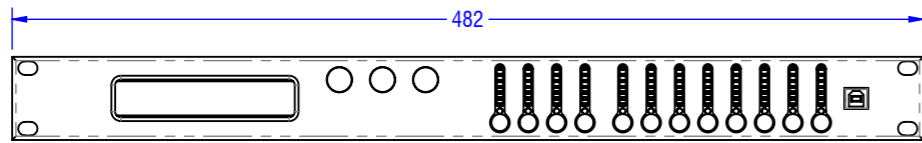

FRONT

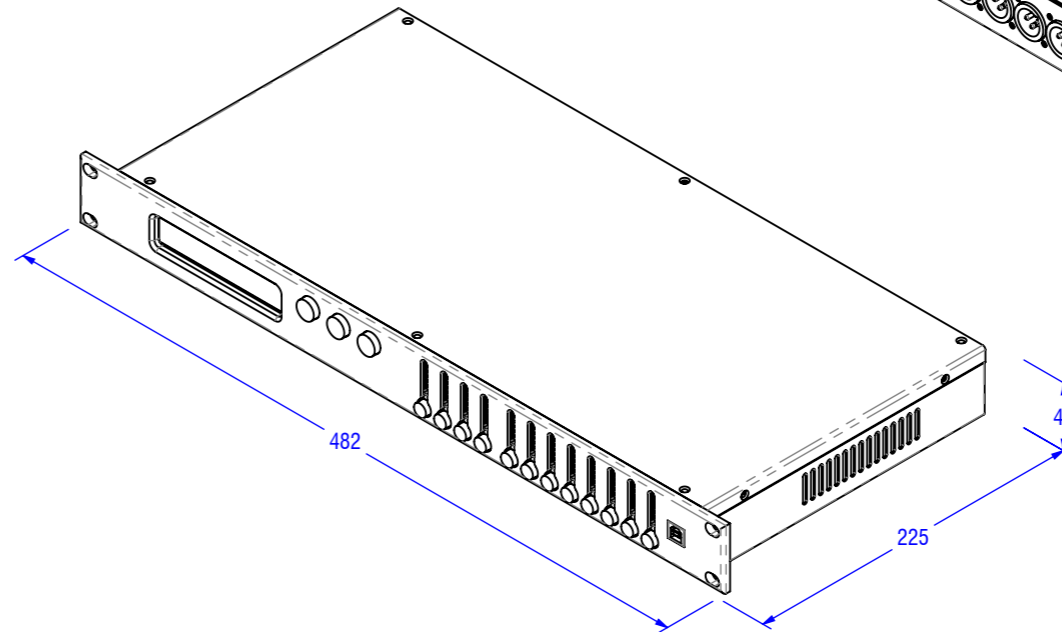

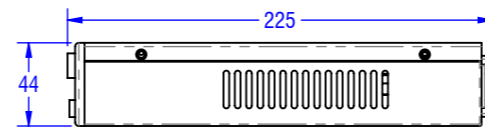

RIGHT





REAR



HH ELECTRONICS LTD
 STEELPARK ROAD, COOMBS WOOD BUSINESS PARK,
 HALESOWEN, WEST MIDLANDS, B62 8HD, UK
 WWW.HHELECTRONICS.CO.UK

DESCRIPTION: PRODUCT ASSEMBLY	PROJECT TITLE: SP48	DWG NO. MCA016035	REVISION: 1
STATE: RELEASED	REFER TO 3D MODEL FOR FULL DIMENSIONAL DATA	DATE: 04/11/2022	RELEASED BY: TB
  UNLESS OTHERWISE STATED: ALL DIMENSIONS ARE IN MILLIMETERS (mm) LINEAR TOLERANCE ± 0.5 ANGULAR TOLERANCE $\pm 1.0^\circ$	THIS DRAWING REMAINS THE PROPERTY OF HH ELECTRONICS LIMITED. THIS DRAWING, HARD COPY OR DIGITAL, AND ANY ATTACHMENTS ARE CONFIDENTIAL, LEGALLY PRIVILEGED AND PROTECTED BY COPYRIGHT.		SCALE: 1:4
		SHEET SIZE: A3	SHEET: 1/1

DESCRIPTION: PRODUCT ASSEMBLY	PROJECT TITLE: SP48	DWG NO. MCA016035	REVISION: 1
STATE: RELEASED	REFER TO 3D MODEL FOR FULL DIMENSIONAL DATA	DATE: 04/11/2022	RELEASED BY: TB
  UNLESS OTHERWISE STATED: ALL DIMENSIONS ARE IN MILLIMETERS (mm) LINEAR TOLERANCE ± 0.5 ANGULAR TOLERANCE $\pm 1.0^\circ$	THIS DRAWING REMAINS THE PROPERTY OF HH ELECTRONICS LIMITED. THIS DRAWING, HARD COPY OR DIGITAL, AND ANY ATTACHMENTS ARE CONFIDENTIAL, LEGALLY PRIVILEGED AND PROTECTED BY COPYRIGHT.		SCALE: 1:4
		SHEET SIZE: A3	SHEET: 1/1